

PLANTA DE CONJUNTO ESCALA 1:100

PROYECTO  
**MUSEO HISTORICO DE SANTA ROSA**

PROPIETARIO  
**DIRECCION GENERAL DE MUSEOS**

Provincia GUANACASTE	Cantón SANTA ROSA	Distrito
-------------------------	----------------------	----------

MUSEOLOGIA:

MUSEOGRAFIA:

DIBUJANTE: M E M O

CONTENIDO

**PLANTA DE CONJUNTO**

ESCALA 1:100	FECHA DICIEMBRE 1997	LAMINA
-----------------	-------------------------	--------

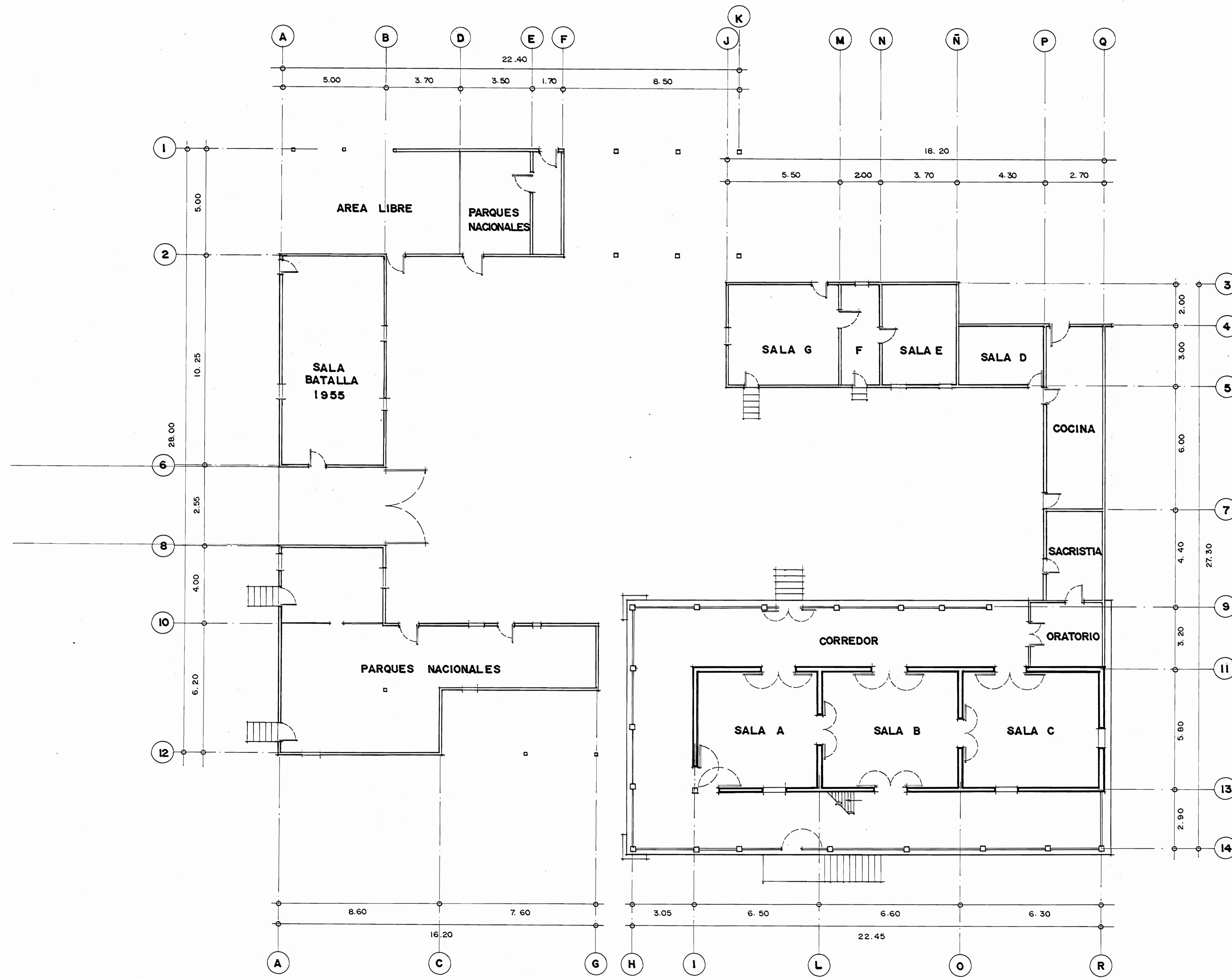

PLANTA DE CONJUNTO ESCALA 1:100

PROYECTO		
MUSEO HISTORICO SANTA ROSA		
PROPIETARIO		
DIRECCION GENERAL DE MUSEOS		
MINISTERIO DE CULTURA, JUVENTUD Y DEPORTES		
Provincia	Contón	Distrito
GUANACASTE	SANTA ROSA	
MUSEOLOGIA:		
MUSEOGRAFIA:		
DIBUJANTE: M E M O		
CONTENIDO		
PLANTA DE CONJUNTO		
ESCALA	FECHA	LAMINA
1:100	DICIEMBRE 1987	2

PLANTA DE DISTRIBUCION DEL MUSEO HISTORICO ESCALA 1:50

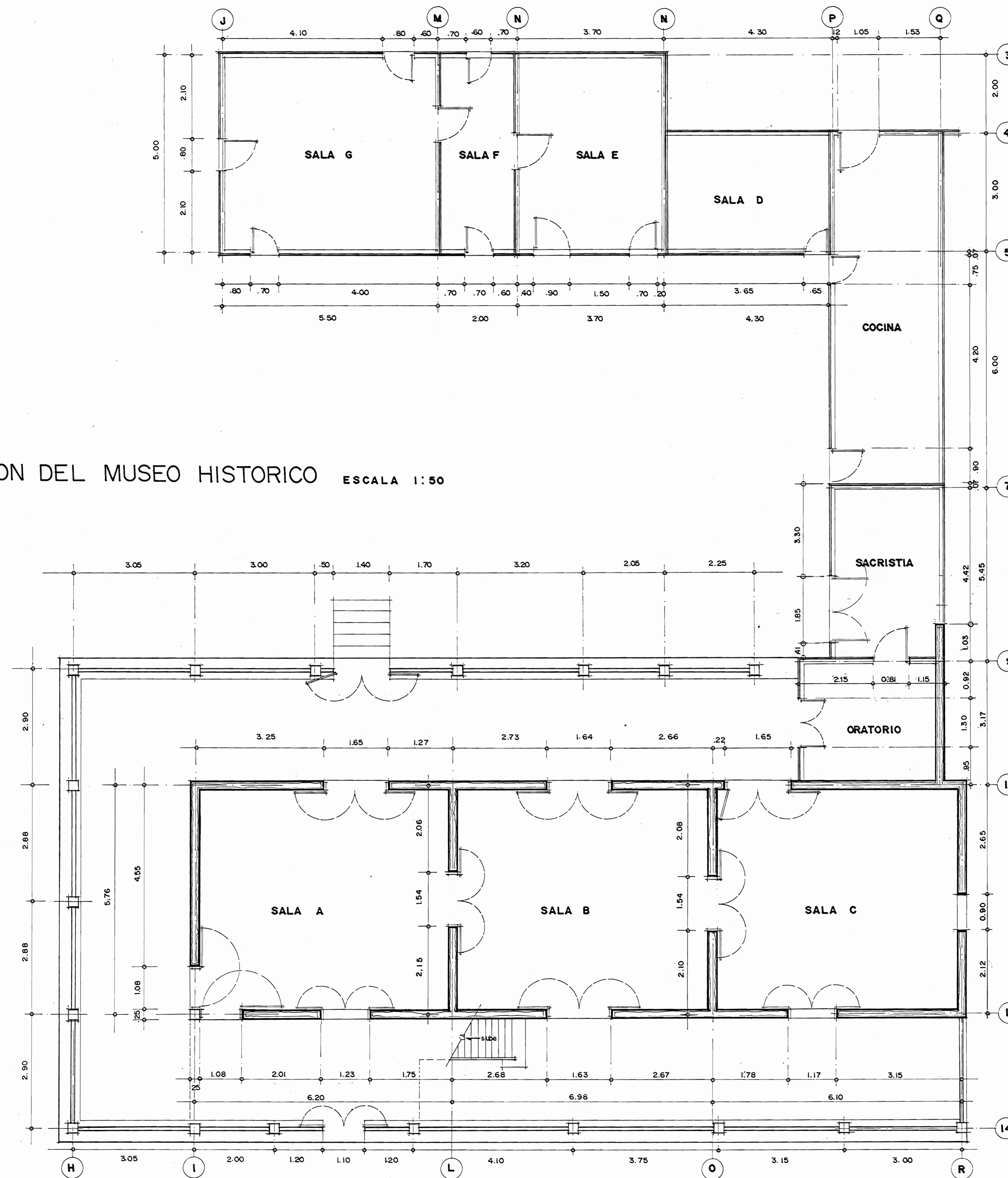

ESPECIFICACIONES

PROYECTO		
MUSEO HISTORICO DE SANTA ROSA		
DIRECCION GENERAL DE MUSEOS		
MINISTERIO DE CULTURA, JUVENTUD Y DEPORTES		
PROVINCIA	CANTON	
GUANACASTE	SANTA ROSA	
MUSEOLOGIA:		
MUSEOGRAFIA:		
DIBUJANTE: M E M O		
CONTENIDO		
PLANTA DE DISTRIBUCION MUSEO HISTORICO		
ESCALA	FECHA	LAMINA
1:50	DICIEMBRE 87	3

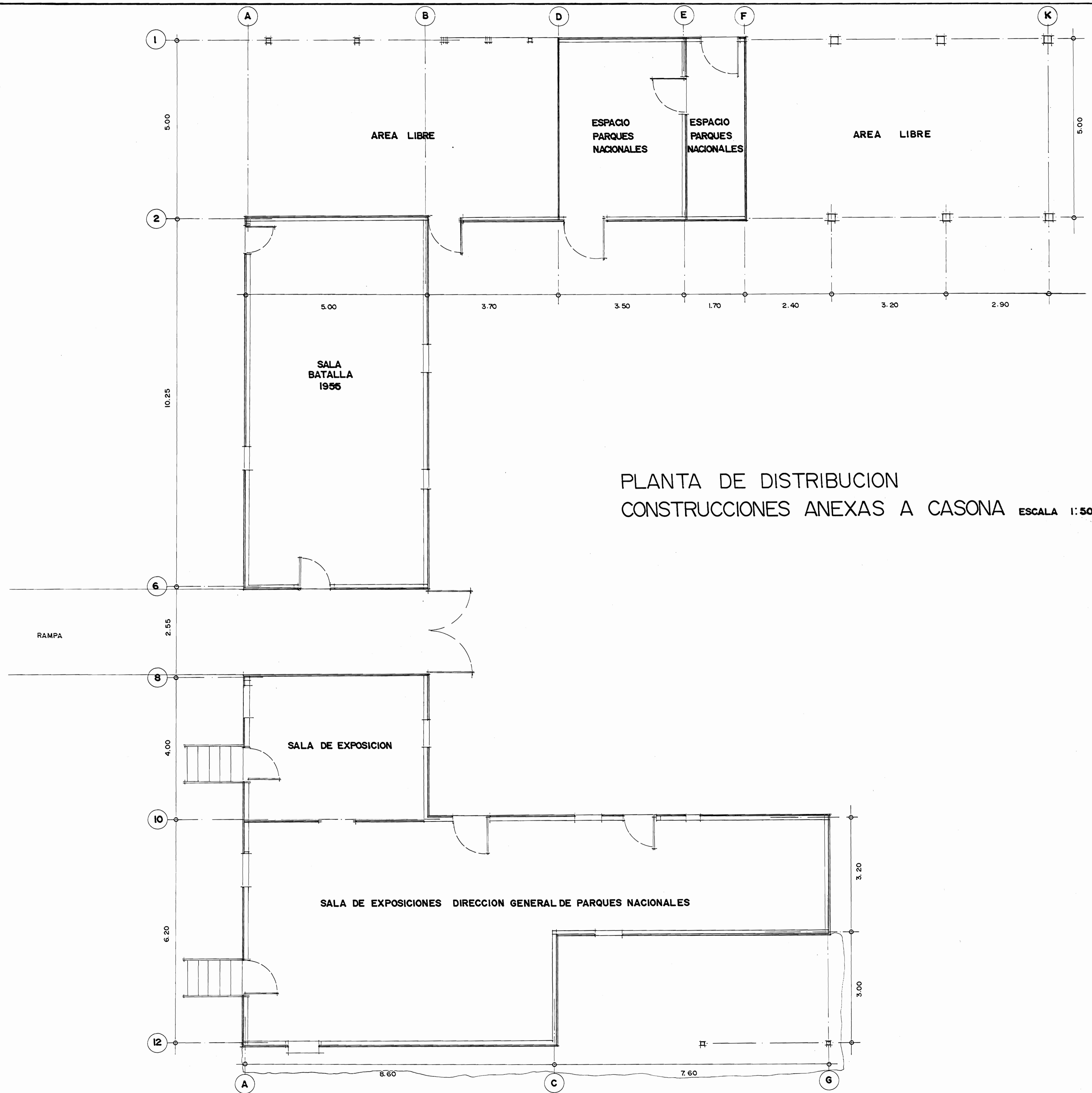

PLANTA DE DISTRIBUCION  
 CONSTRUCCIONES ANEXAS A CASONA ESCALA 1:50

ESPECIFICACIONES

PROYECTO		
MUSEO HISTORICO DE SANTA ROSA		
CONTENIDO		
PLANTA DE DISTRIBUCION CONSTRUCCIONES ANEXAS		
ESCALA	FECHA	LAMINA
1:50	DICIEMBRE 1987	4



FACHADA MUSEOGRAFICA POSTERIOR



FACHADA MUSEOGRAFICA PRINCIPAL

PROYECTO		
MUSEO HISTORICO SANTA ROSA		
CONTENIDO		
FACHADAS MUSEOGRAFICAS DE LA CASONA		
ESCALA	FECHA	LAMINA
1:50	DICIEMBRE 1987	5

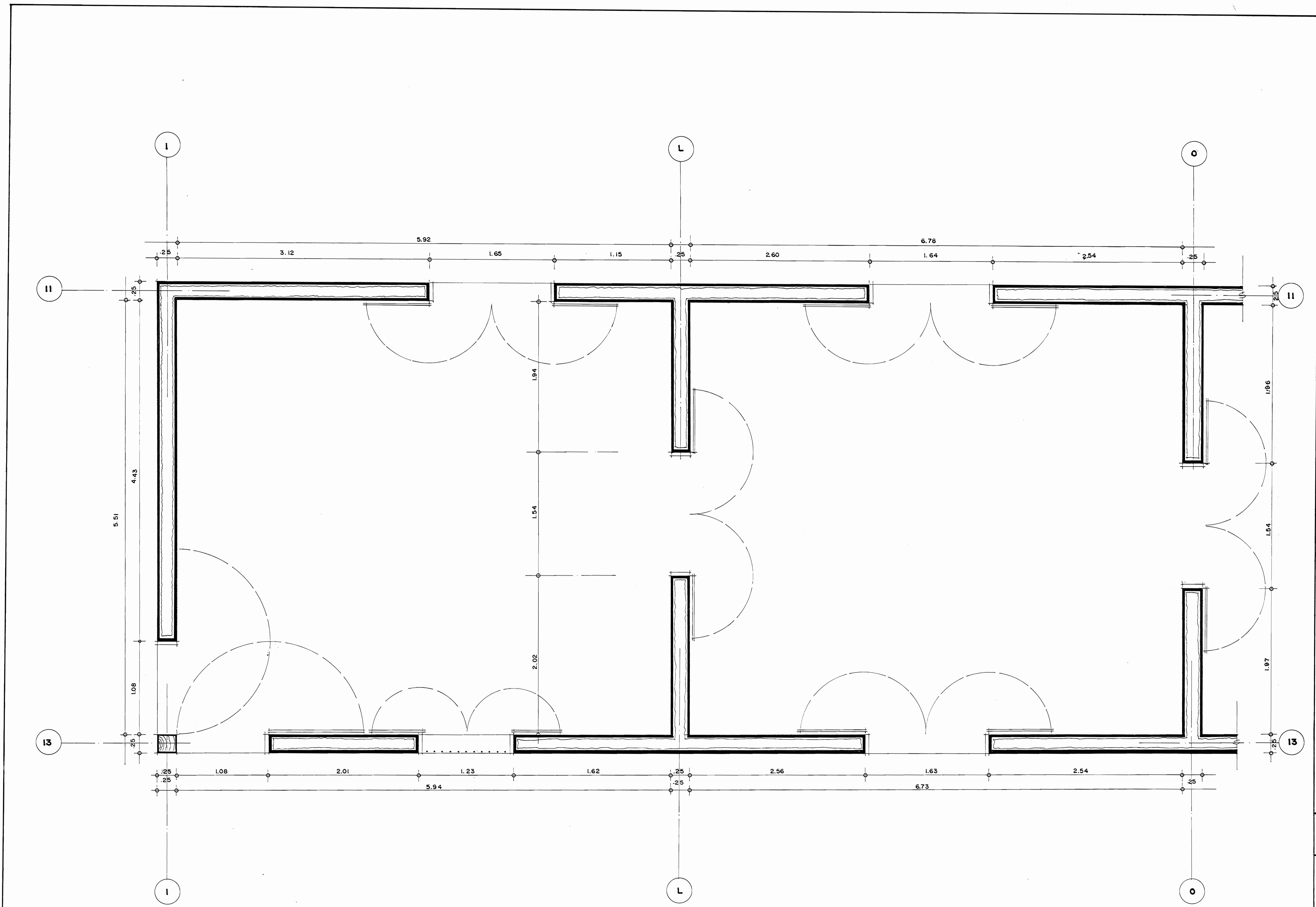

PLANTA MUSEOGRAFICA SALA A Y SALA B

PROYECTO		
MUSEO HISTORICO SANTA ROSA		
CONTENIDO		
PLANTA MUSEOGRAFICA SALAS A Y B		
ESCALA	FECHA	LAMINA
1:20	ENERO 1988	6

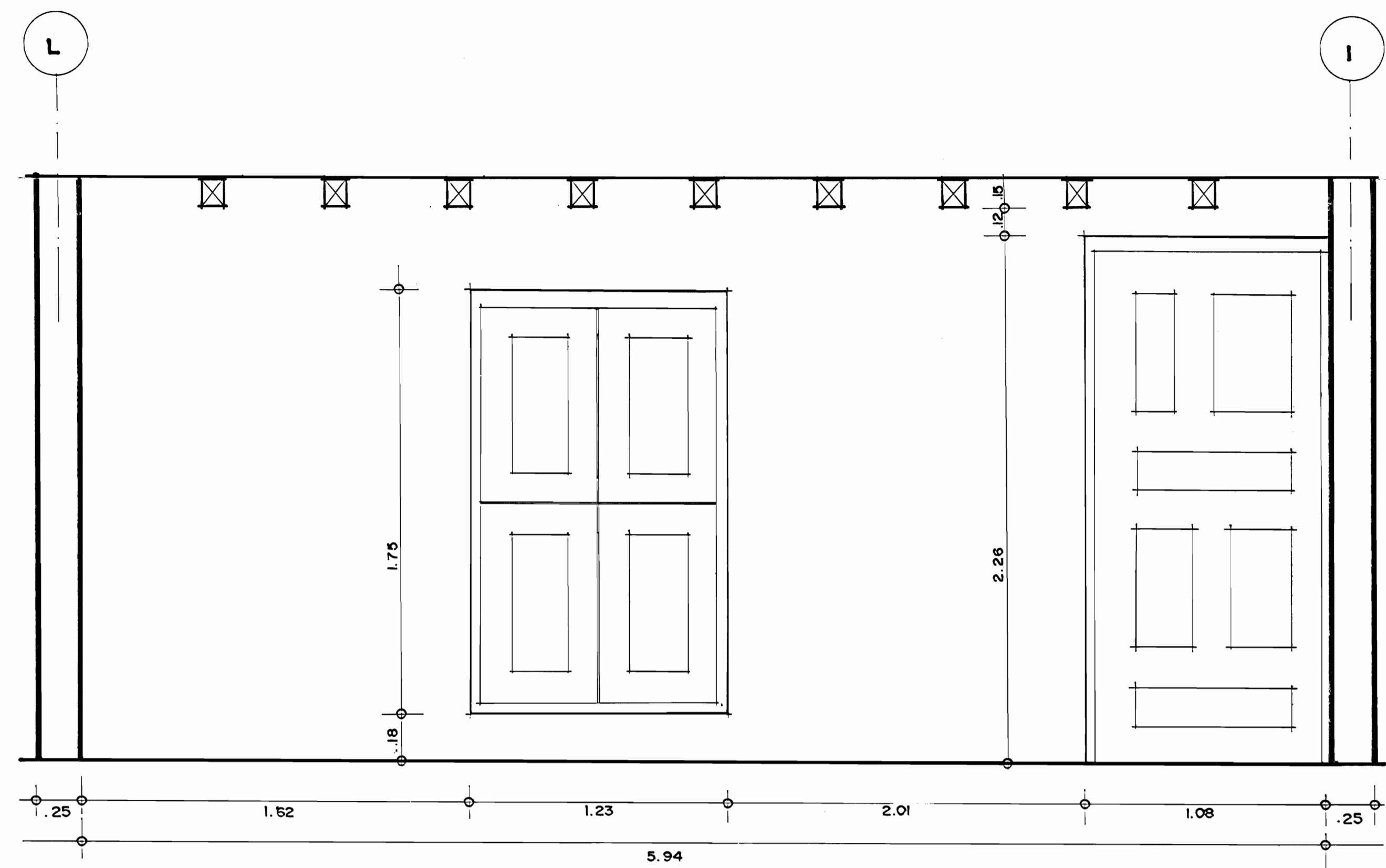

PLANO MUSEOGRAFICO SUR

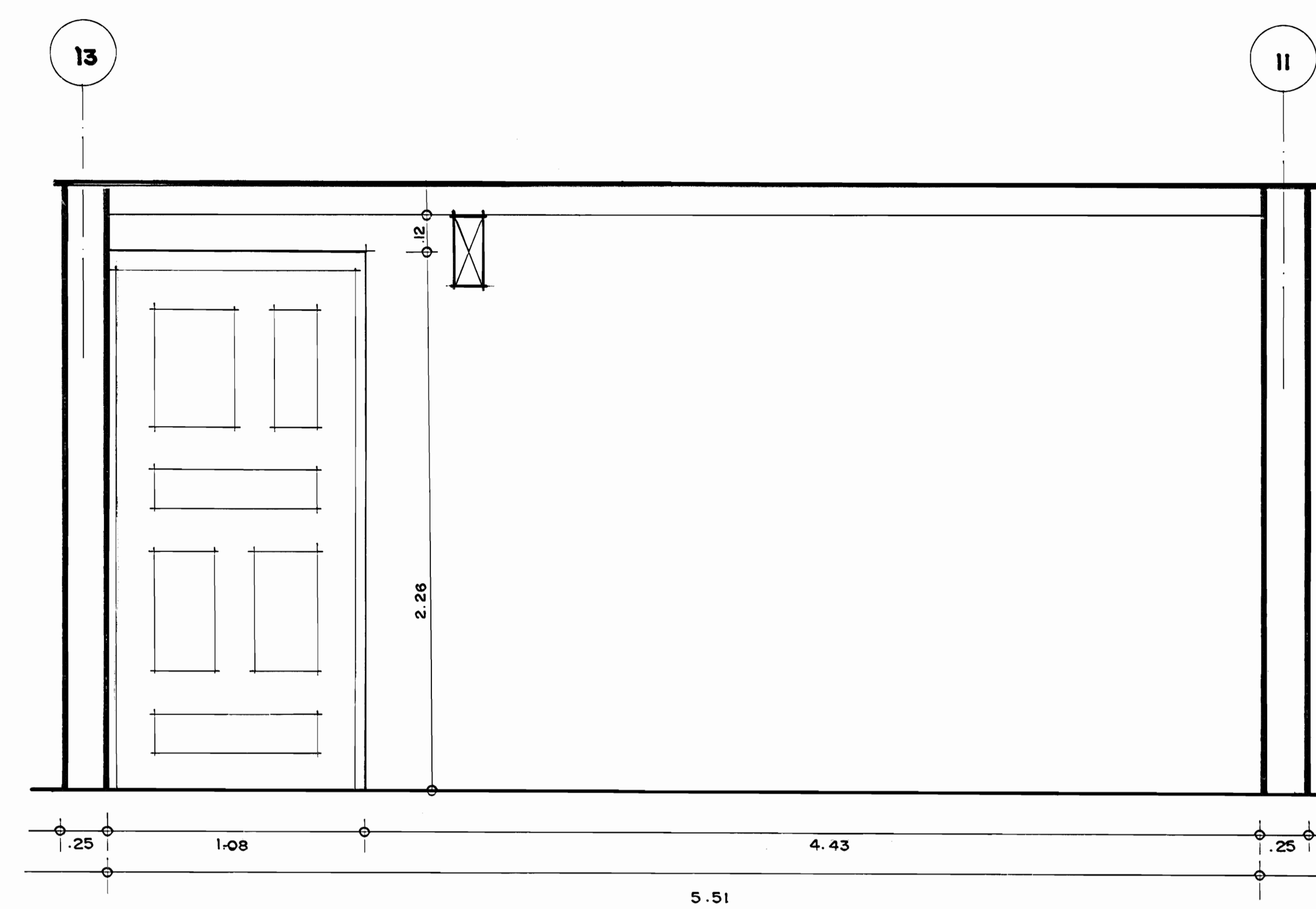

PLANO MUSEOGRAFICO OESTE

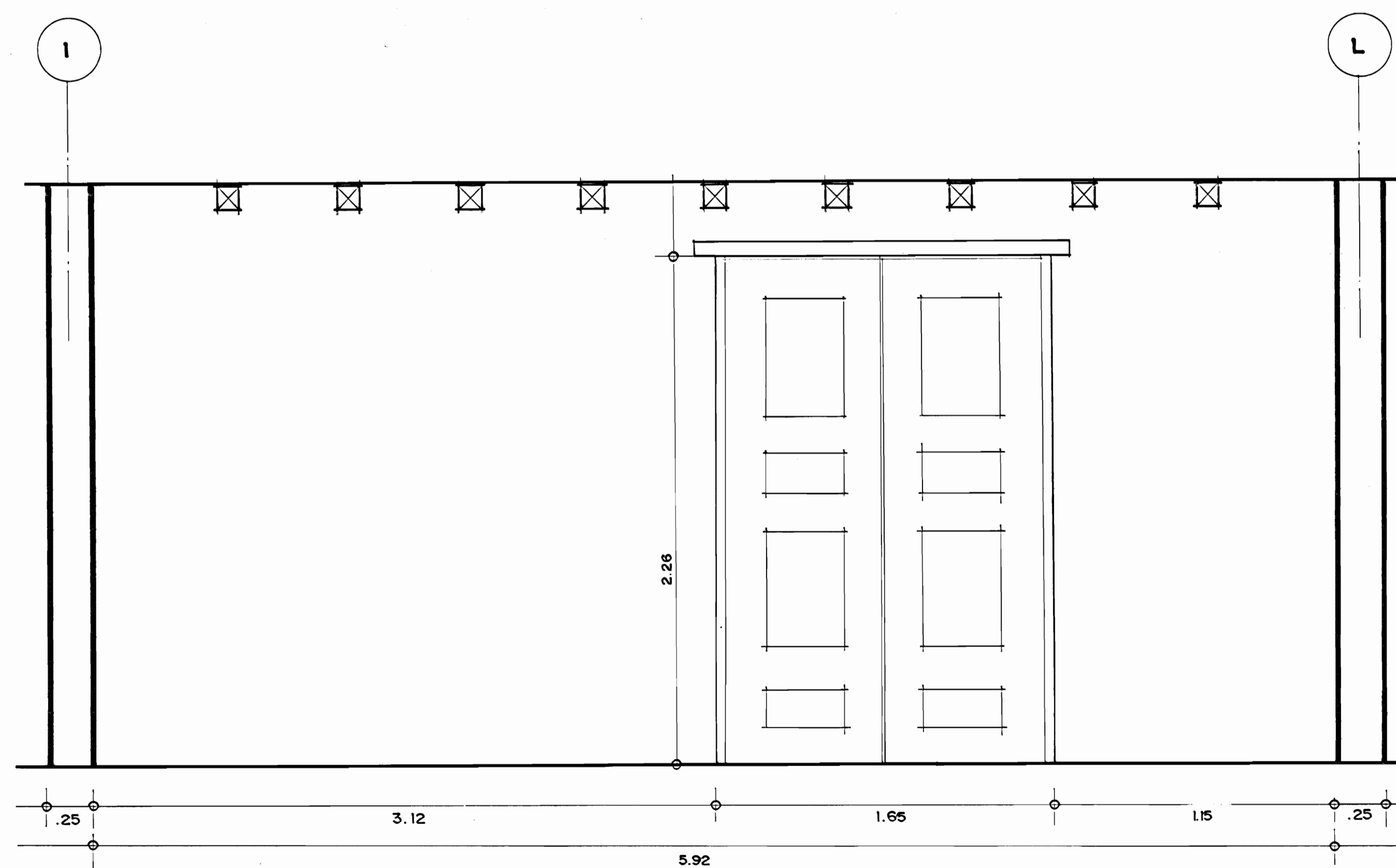

PLANO MUSEOGRAFICO NORTE

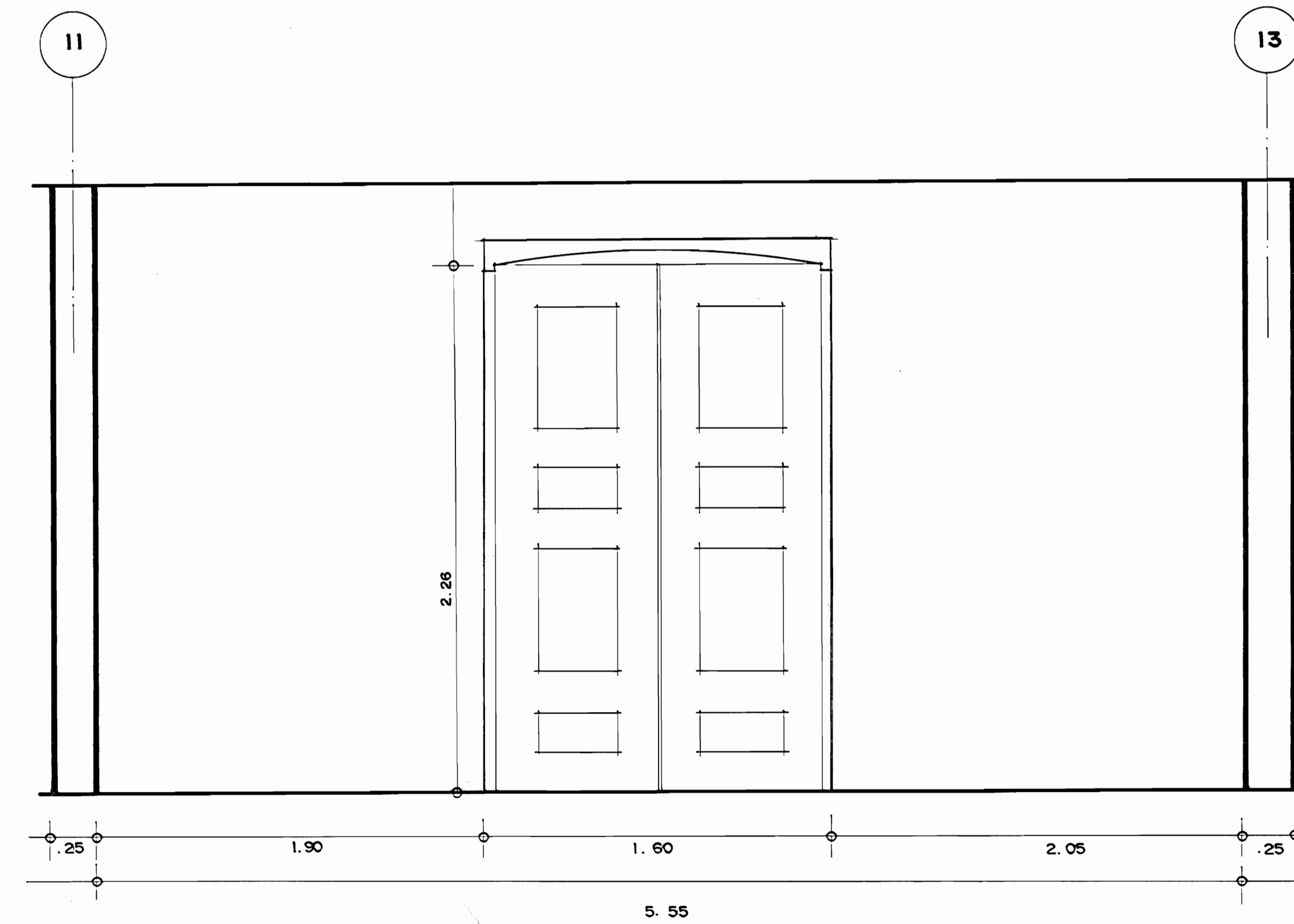

PLANO MUSEOGRAFICO ESTE

PROYECTO		
MUSEO HISTORICO SANTA ROSA		
CONTENIDO		
LAMINA DE ABATIMIENTOS		
SALA A		
ESCALA	FECHA	LAMINA
1:20	ENERO 1988	7

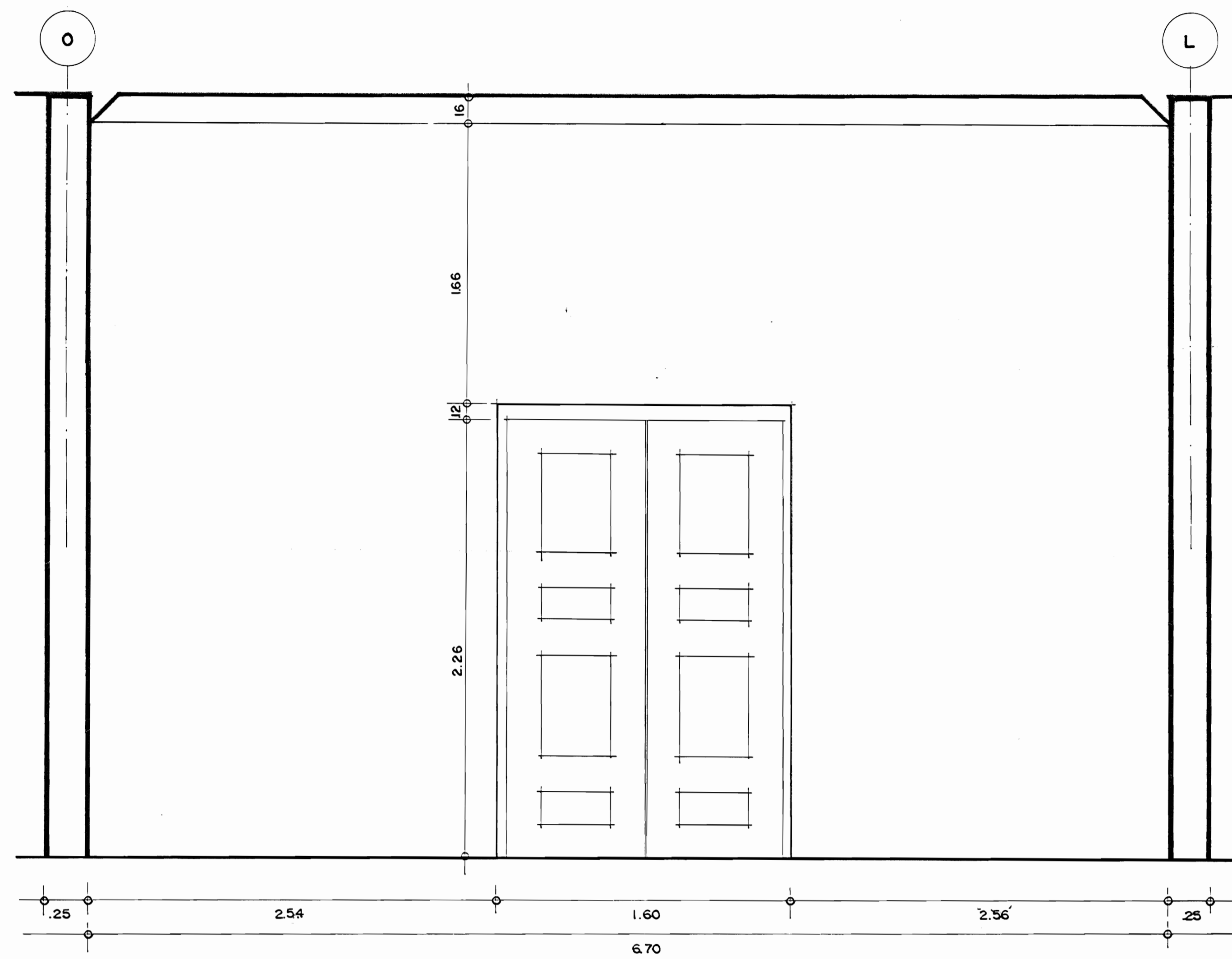

PLANO MUSEOGRAFICO SUR

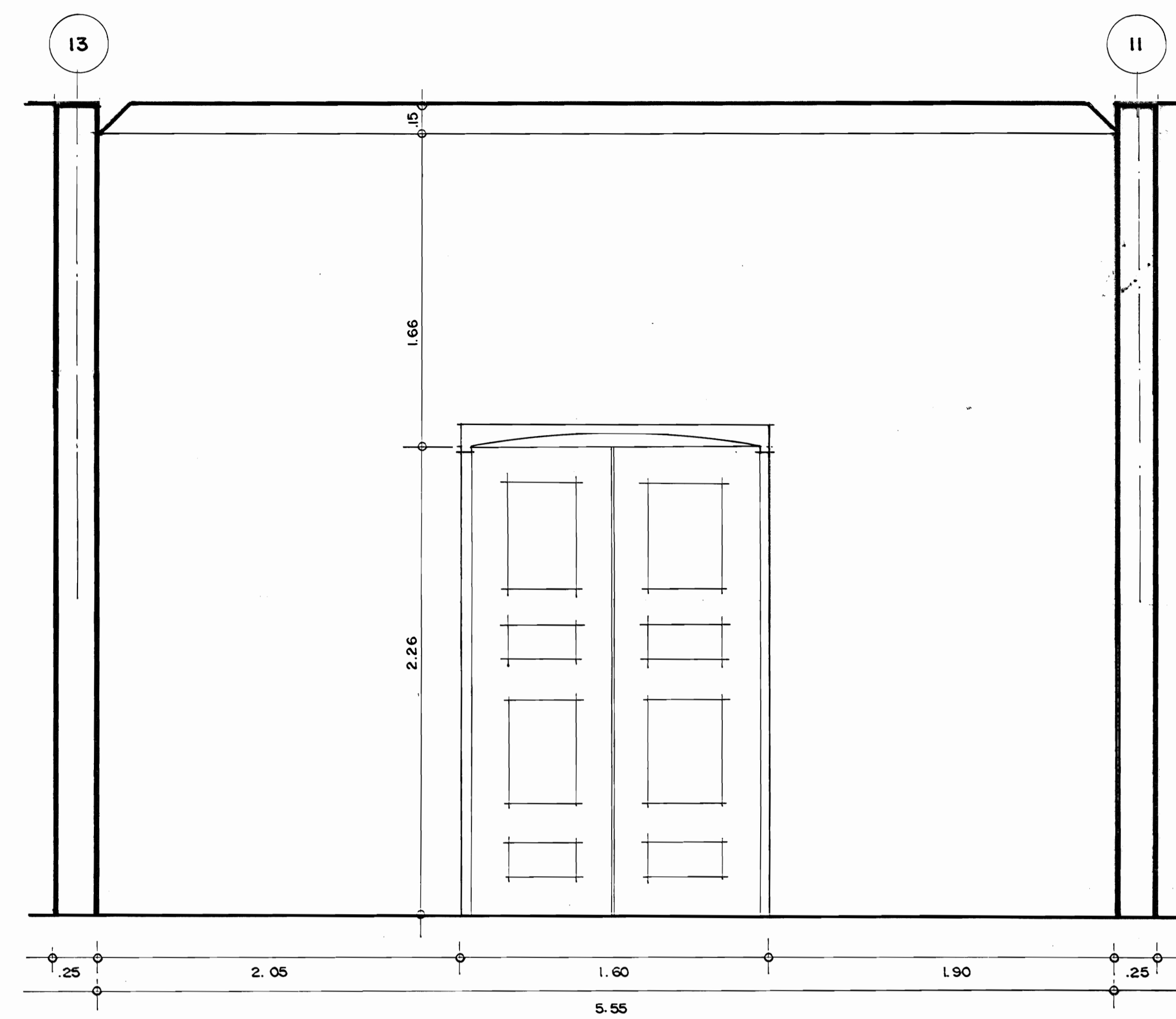

PLANO MUSEOGRAFICO OESTE

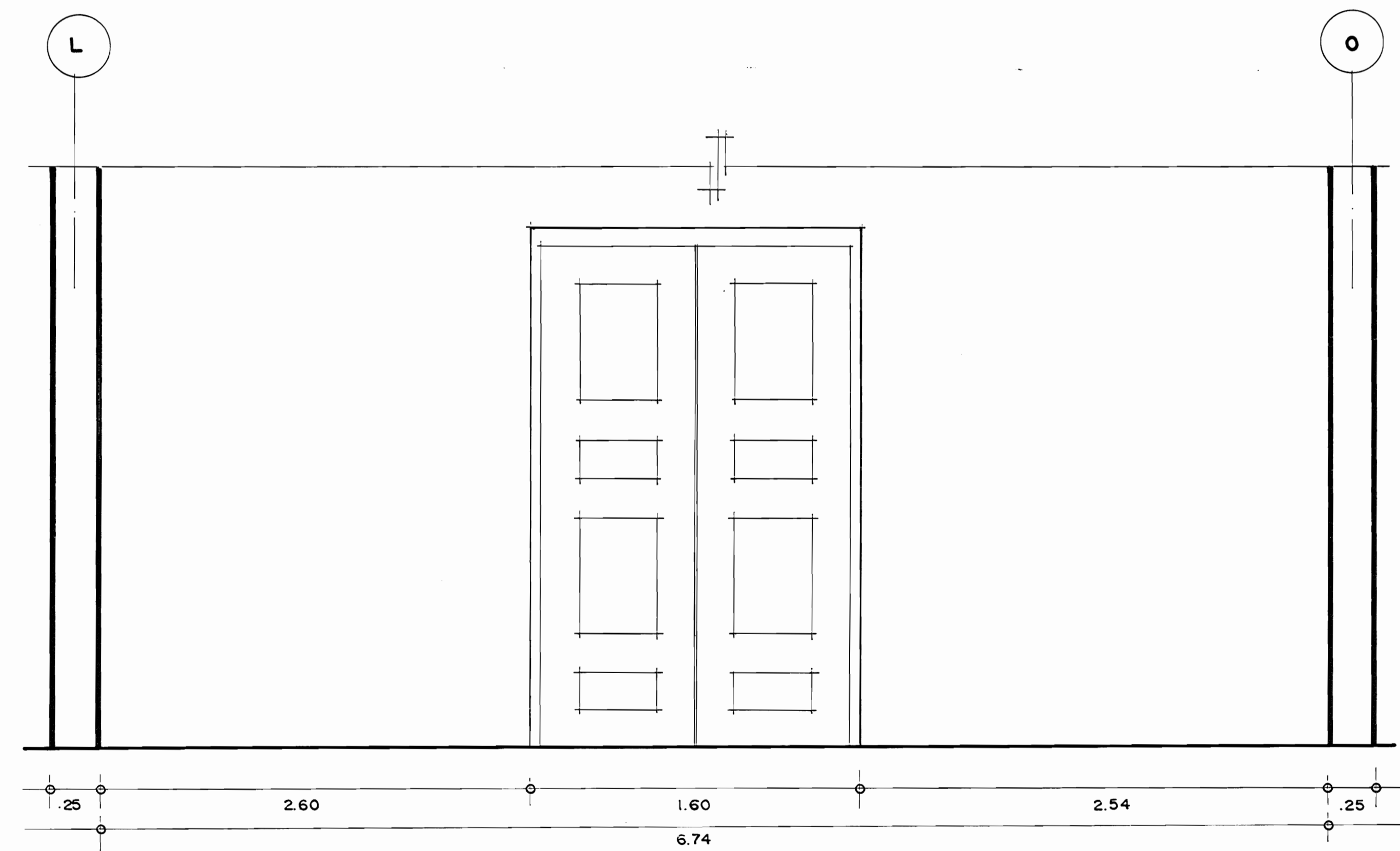

PLANO MUSEOGRAFICO NORTE

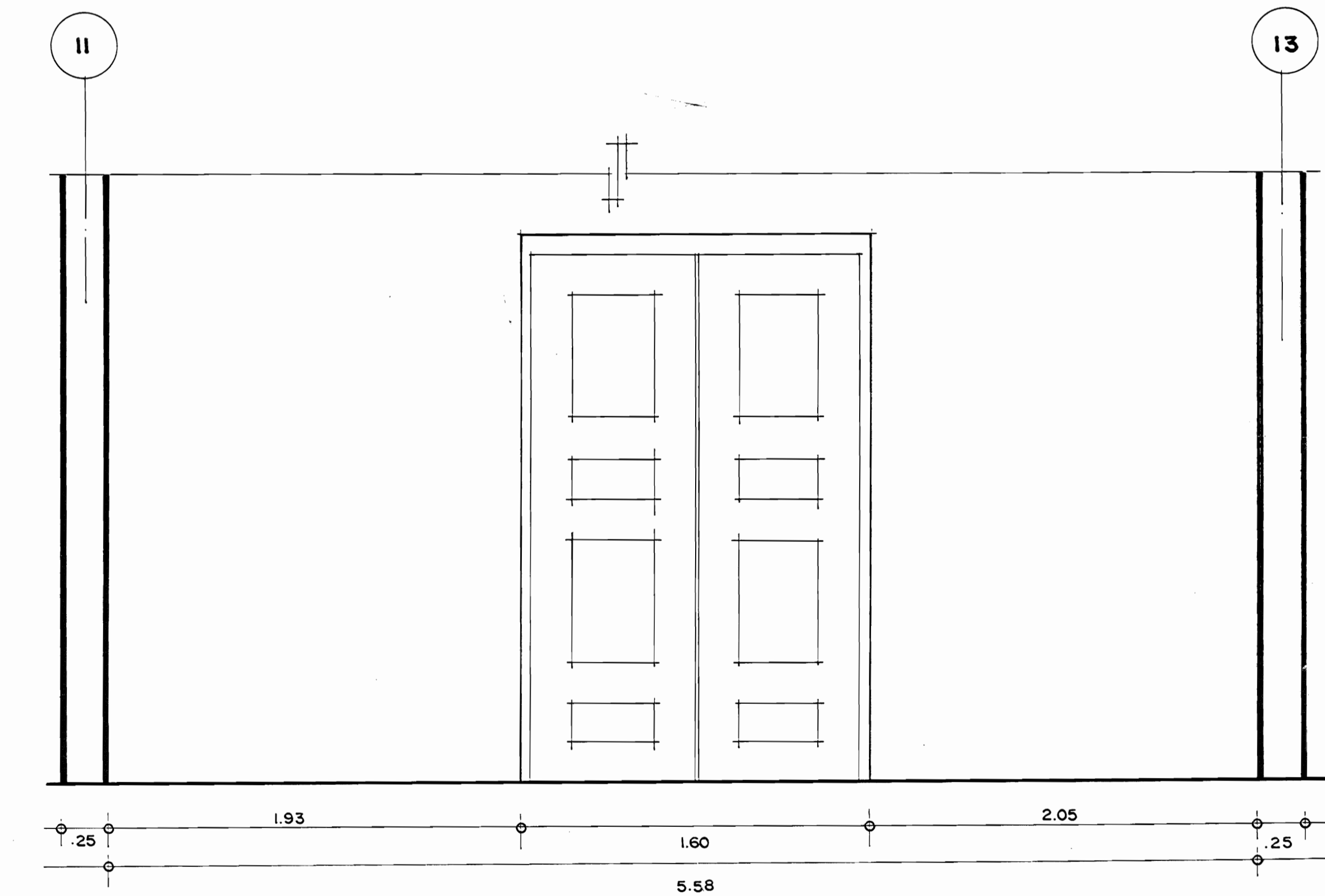

PLANO MUSEOGRAFICO ESTE

ESPECIFICACIONES

PROYECTO		
MUSEO HISTORICO SANTA ROSA		
CONTENIDO		
LAMINA DE ABATIMIENTOS		
SALA B		
ESCALA	FECHA	LAMINA
1: 20	ENERO 1988	8



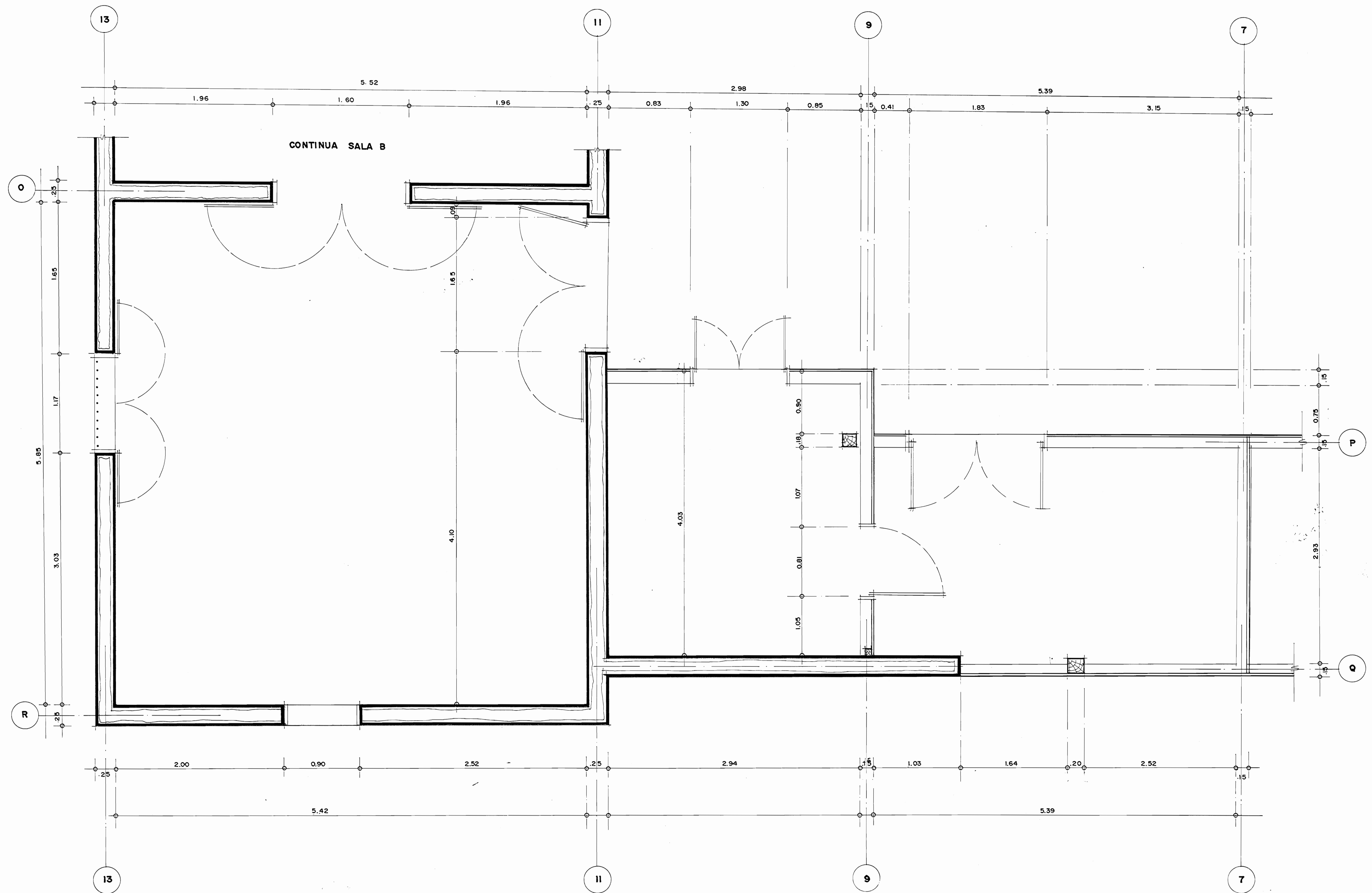

PLANTA MUSEOGRAFICA SALA C, ORATORIO Y SACRISTIA GIRADO 90° A LA DERECHA

PROYECTO		
MUSEO HISTORICO SANTA ROSA		
CONTENIDO		
PLANTA MUSEOGRAFICA		
SALA C, ORATORIO Y SACRISTIA		
(GIRADO 90° A LA DERECHA)		
ESCALA	FECHA	LAMINA
1:20	ENERO 1988	9

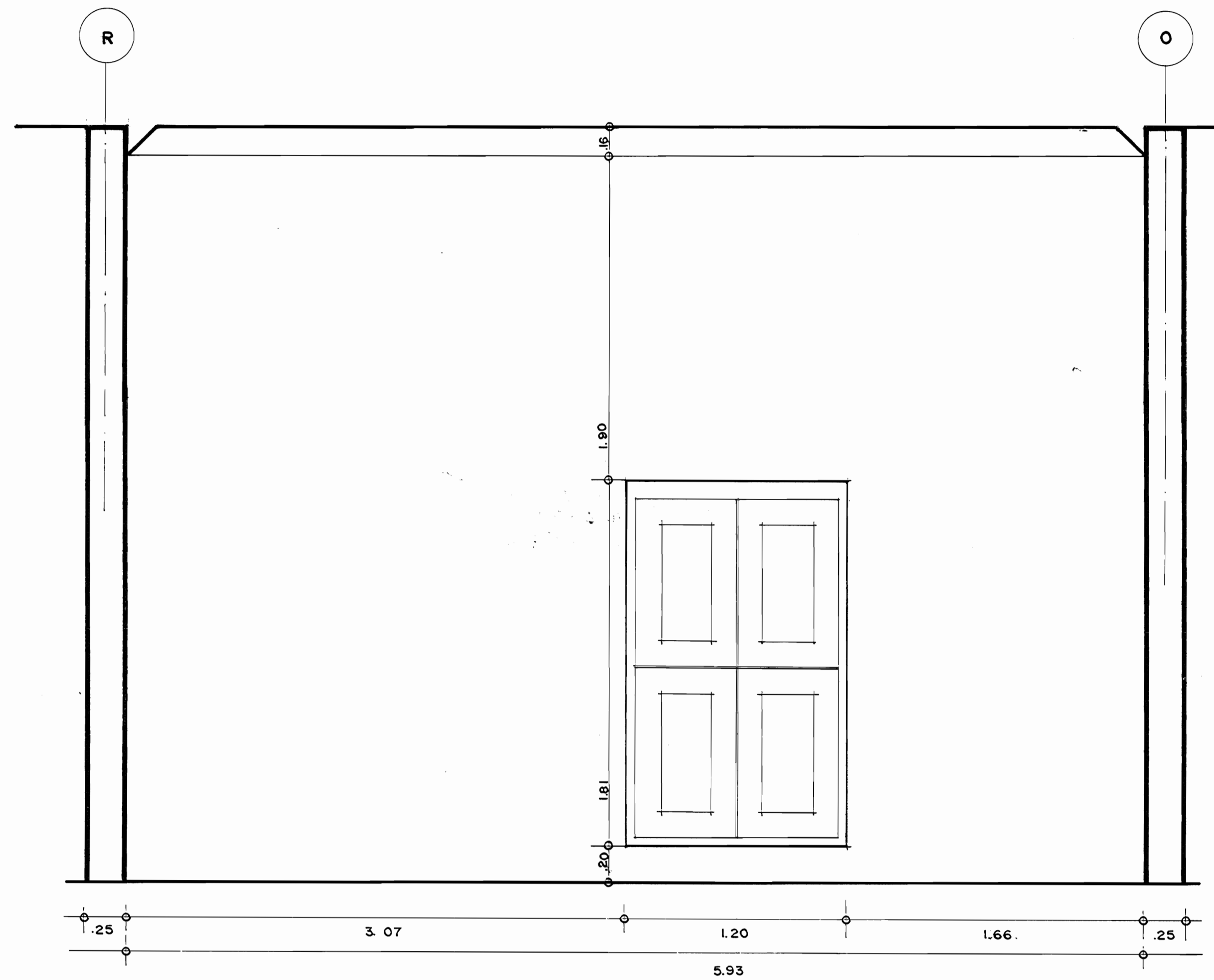

PLANO MUSEOGRAFICO SUR

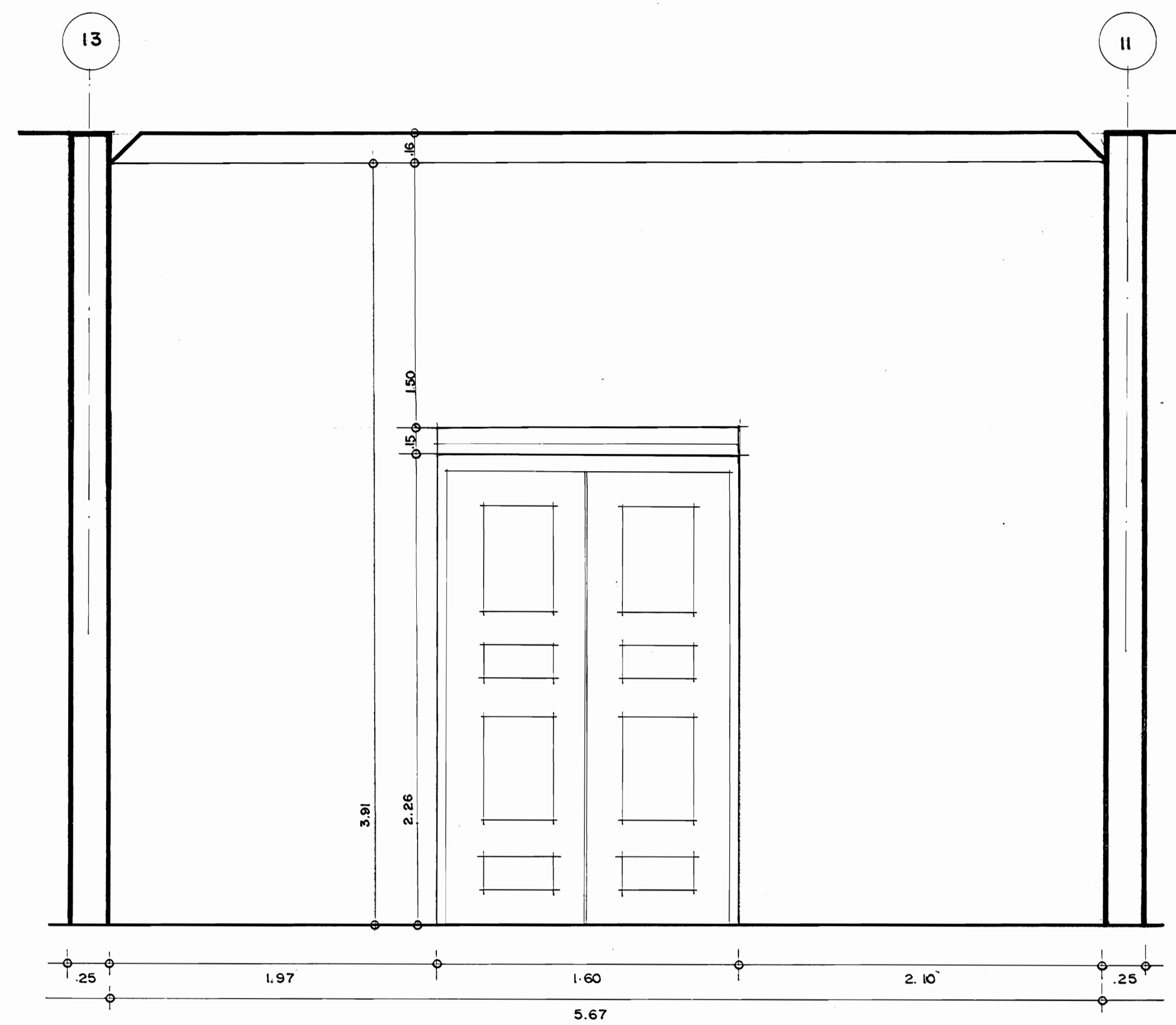

PLANO MUSEOGRAFICO OESTE

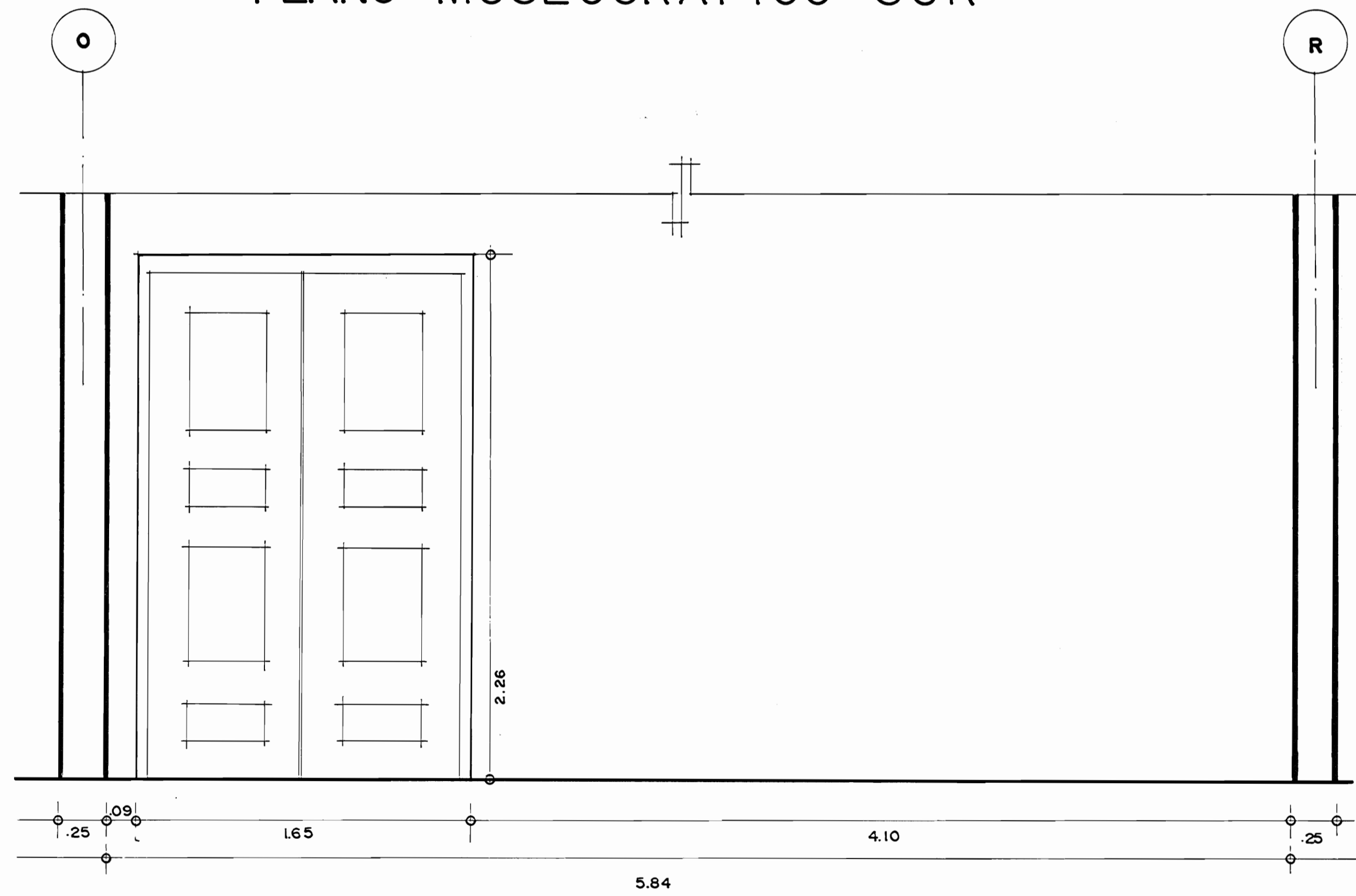

PLANO MUSEOGRAFICO NORTE

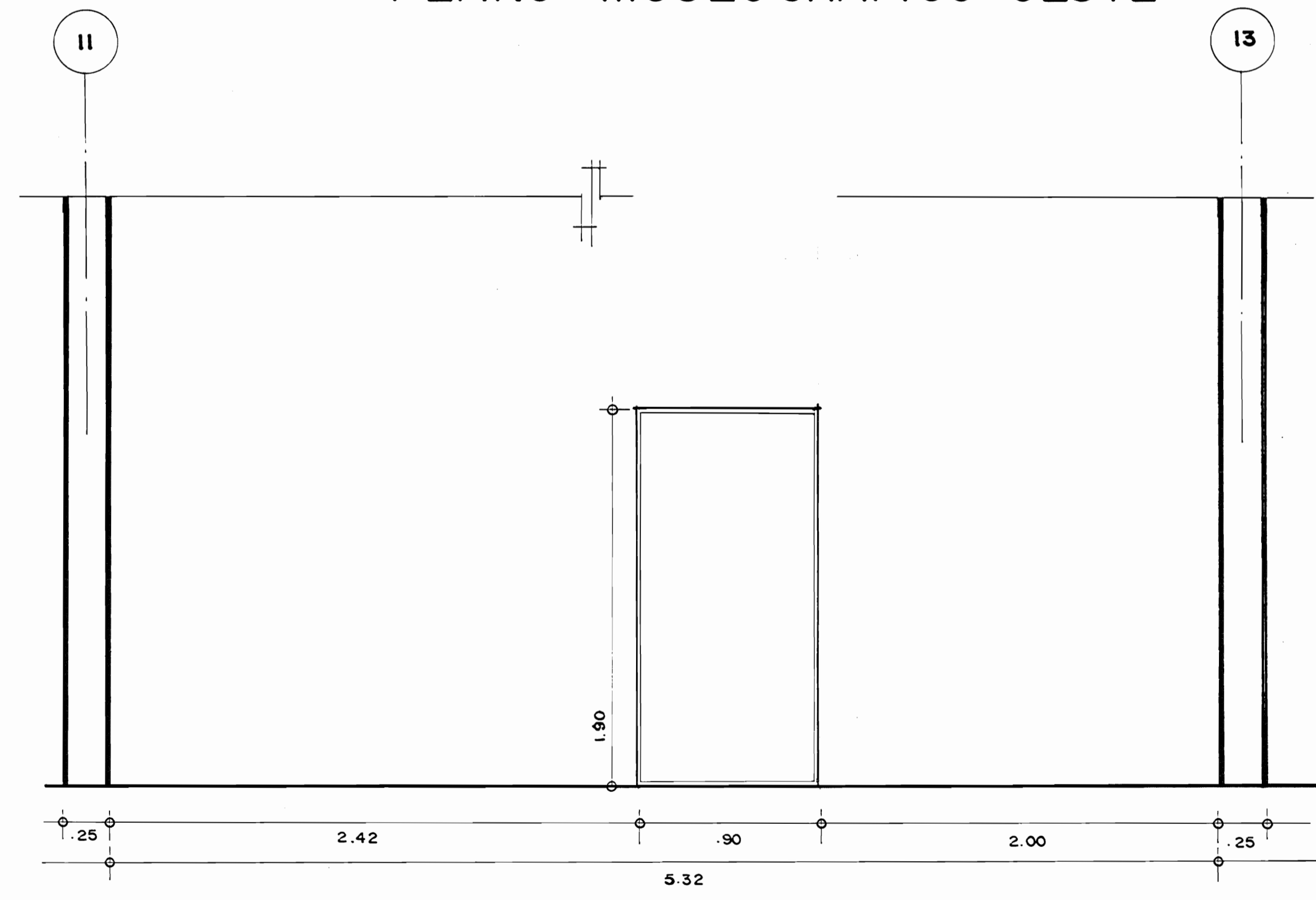

PLANO MUSEOGRAFICO ESTE

PROYECTO		
MUSEO HISTORICO SANTA ROSA		
CONTENIDO		
LAMINA DE ABATIMIENTOS		
SALA C		
ESCALA	FECHA	LAMINA
1 : 20	ENERO 1988	10

SACRISTIA

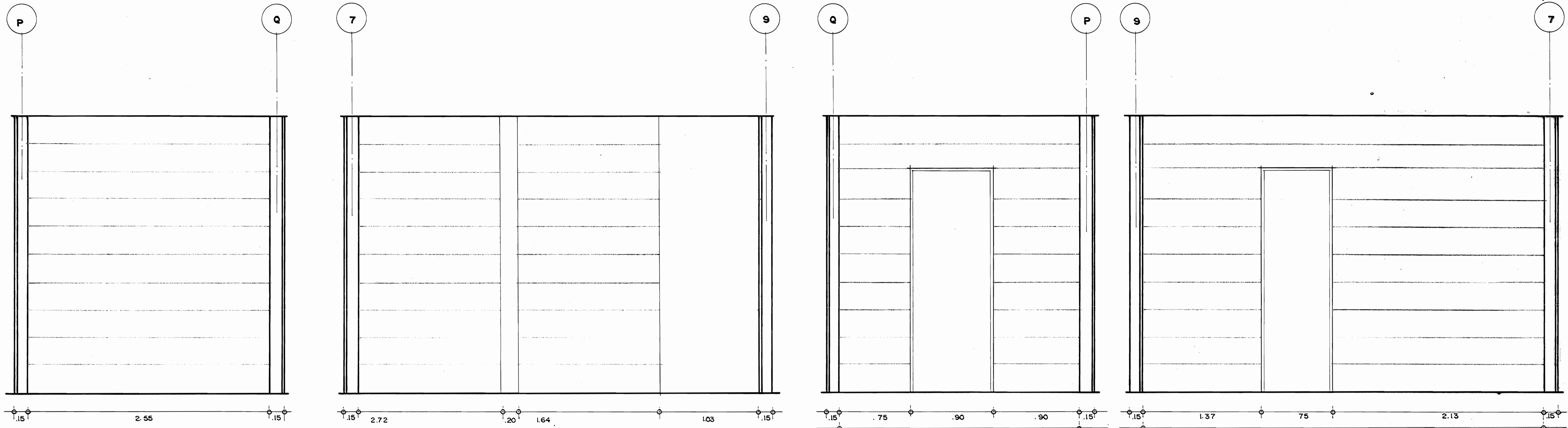

PLANO MUSEOGRAFICO NORTE

PLANO MUSEOGRAFICO ESTE

PLANO MUSEOGRAFICO SUR

PLANO MUSEOGRAFICO OESTE

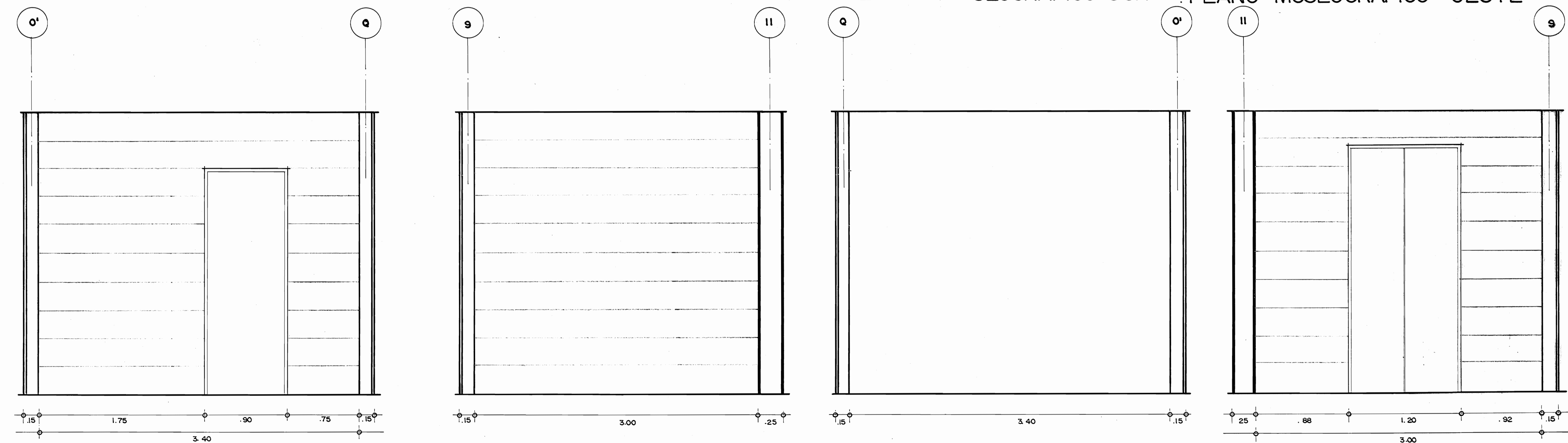

PLANO MUSEOGRAFICO NORTE

PLANO MUSEOGRAFICO ESTE

PLANO MUSEOGRAFICO SUR

PLANO MUSEOGRAFICO OESTE

ORATORIO

PROYECTO		
MUSEO HISTORICO SANTA ROSA		
CONTENIDO		
LAMINA DE ABATIMIENTOS ORATORIO Y SACRISTIA		
ESCALA	FECHA	LAMINA
1:20	ENERO 1988	11

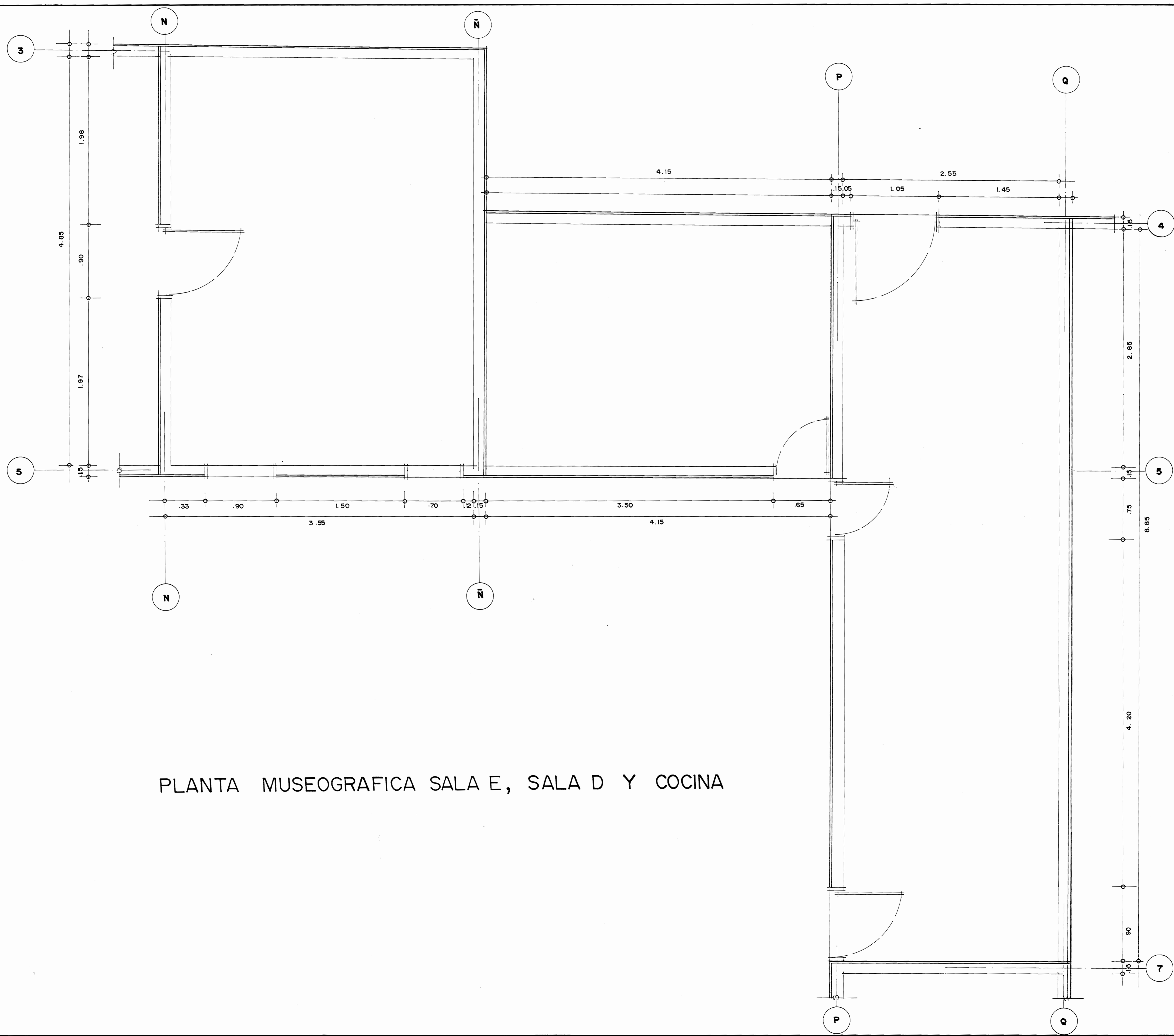

PLANTA MUSEOGRAFICA SALA E, SALA D Y COCINA

ESPECIFICACIONES

PROYECTO		
MUSEO HISTORICO SANTA ROSA		
CONTENIDO		
PLANTA MUSEOGRAFICA SALAS E, D Y COCINA		
ESCALA	FECHA	LAMINA
1:20	ENERO 1988	12

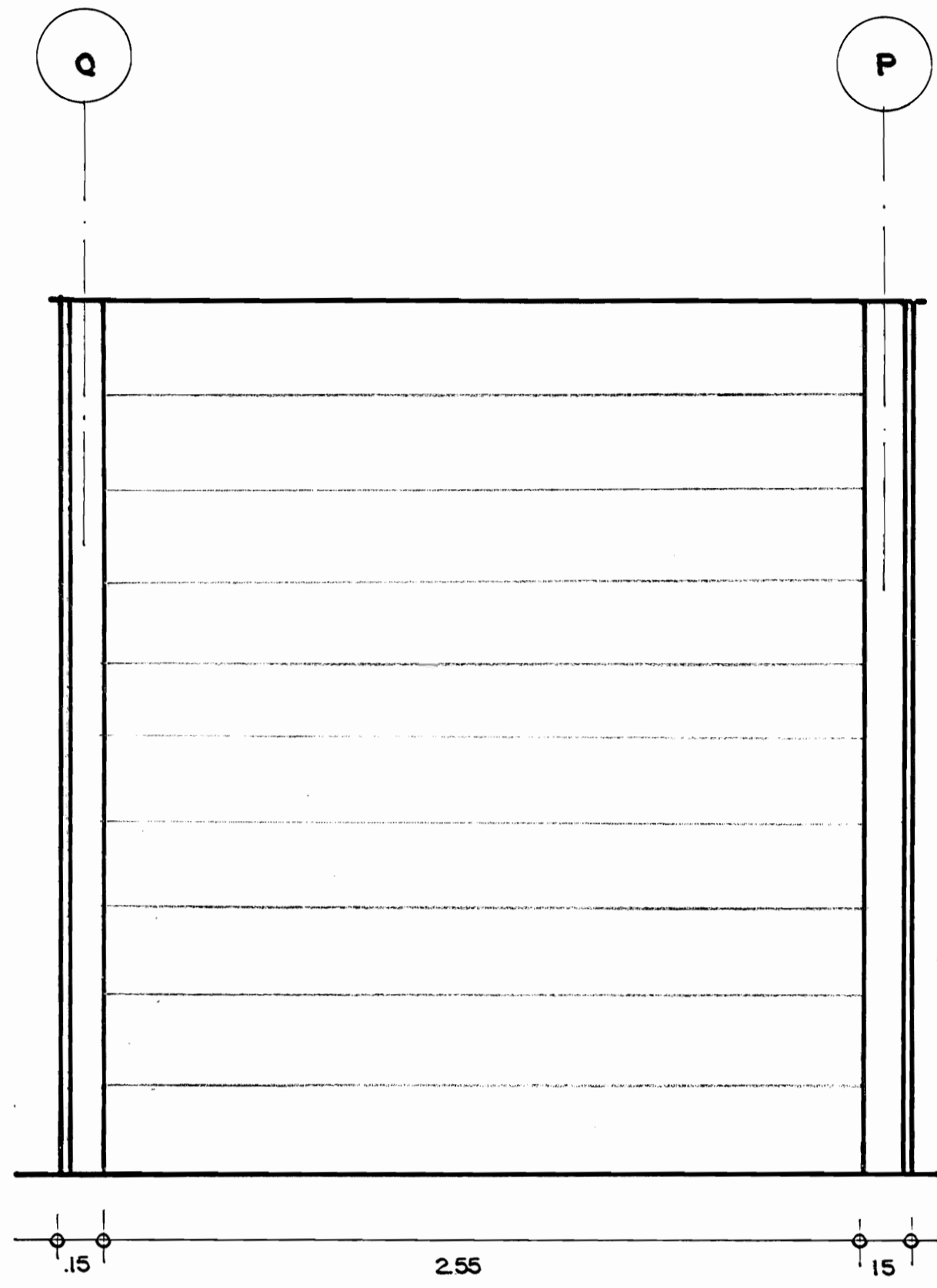

PLANO MUSEOGRAFICO SUR

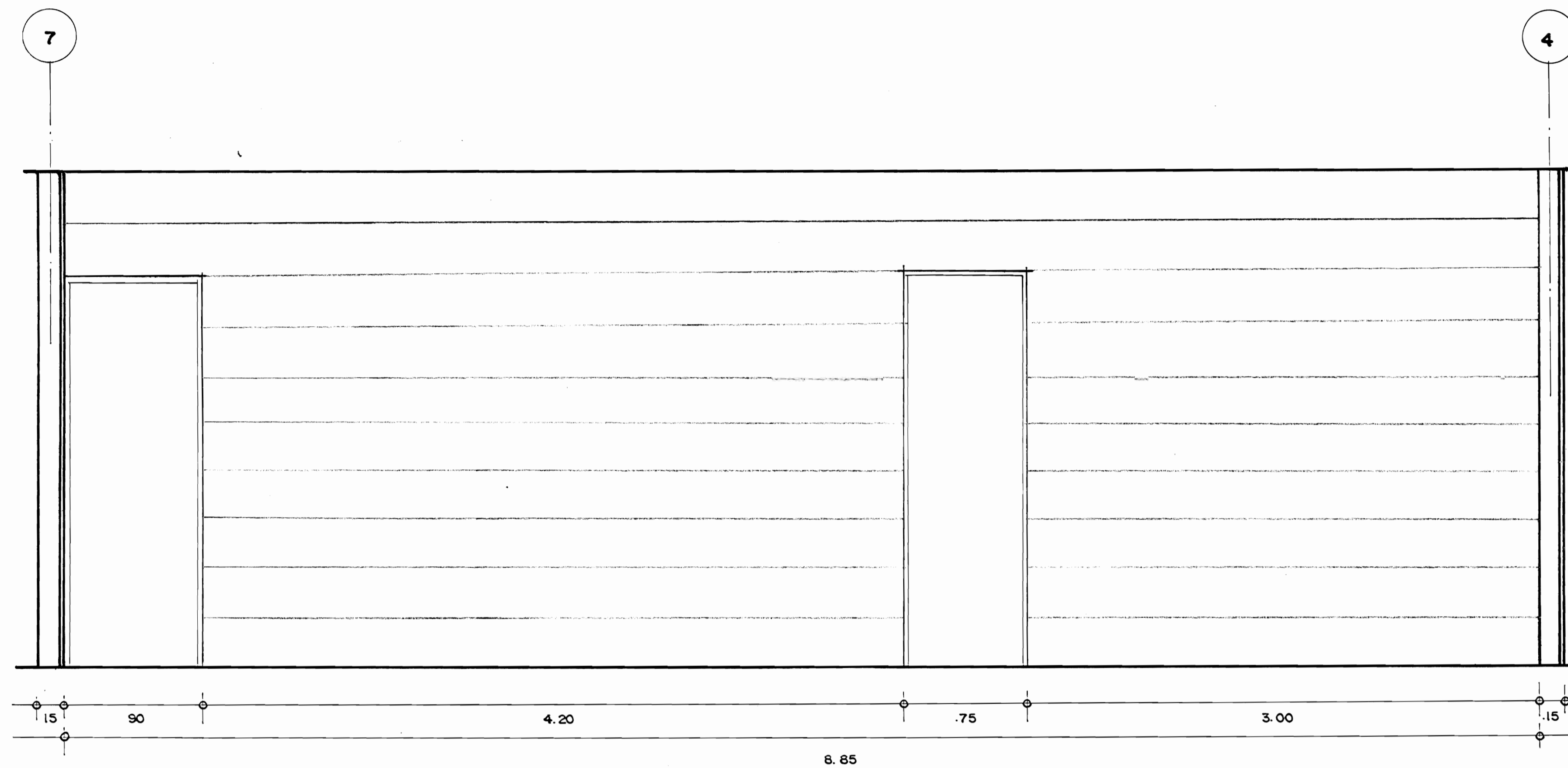

PLANO MUSEOGRAFICO OESTE

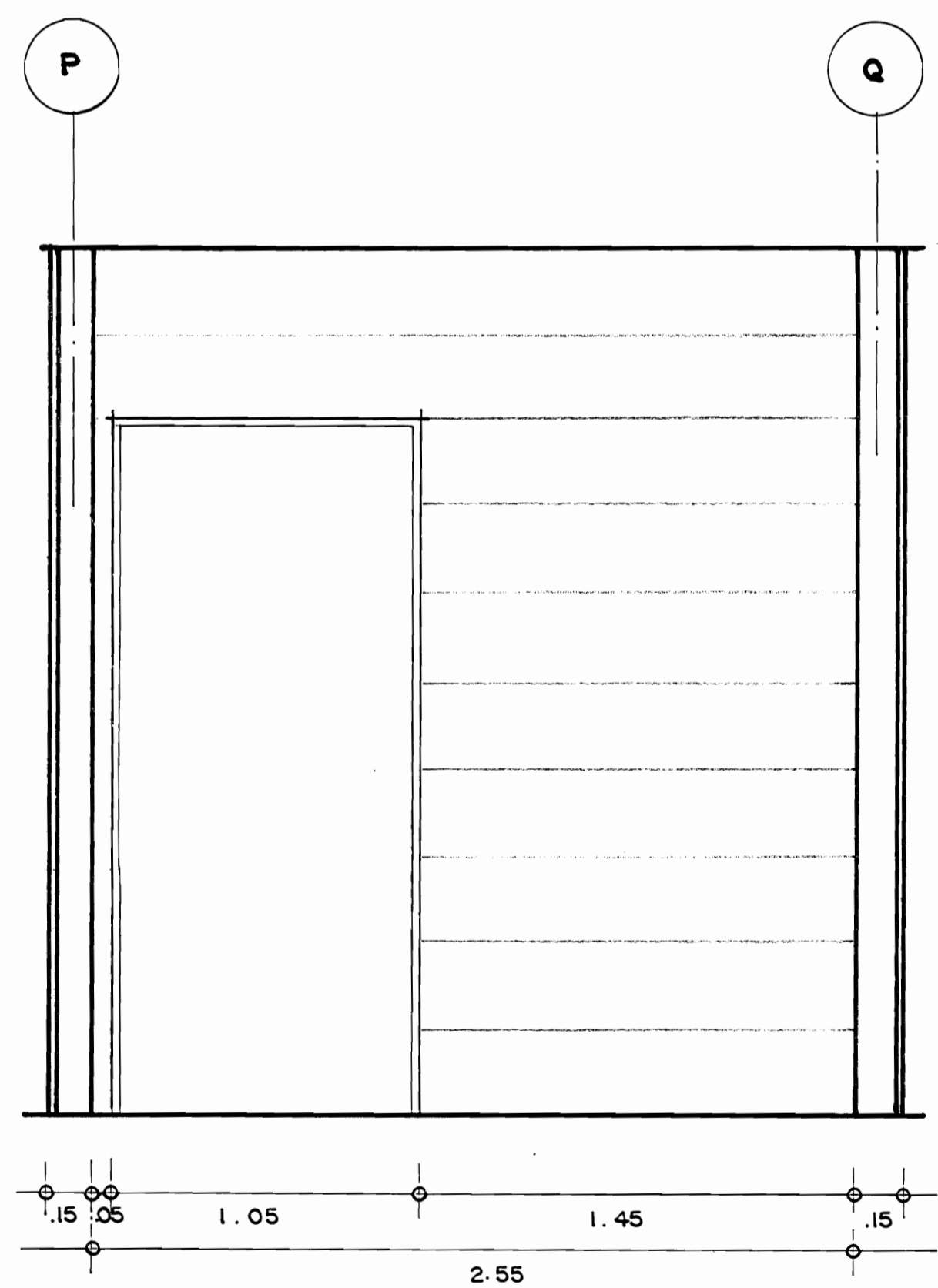

PLANO MUSEOGRAFICO NORTE

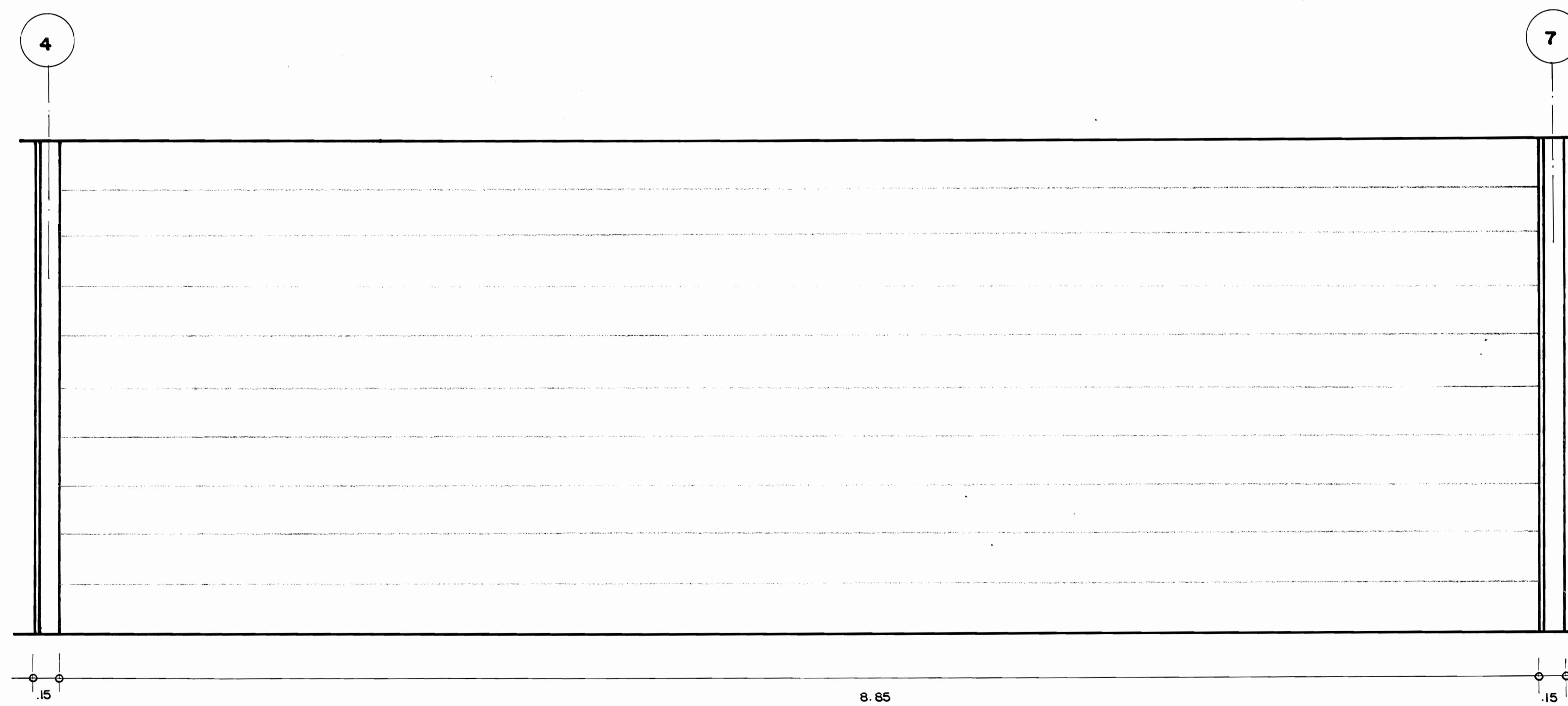

PLANO MUSEOGRAFICO SUR

PROYECTO		
MUSEO HISTORICO SANTA ROSA		
CONTENIDO		
LAMINA DE ABATIMIENTOS COCINA		
ESCALA	FECHA	LAMINA
1 : 20	ENERO 1986	13

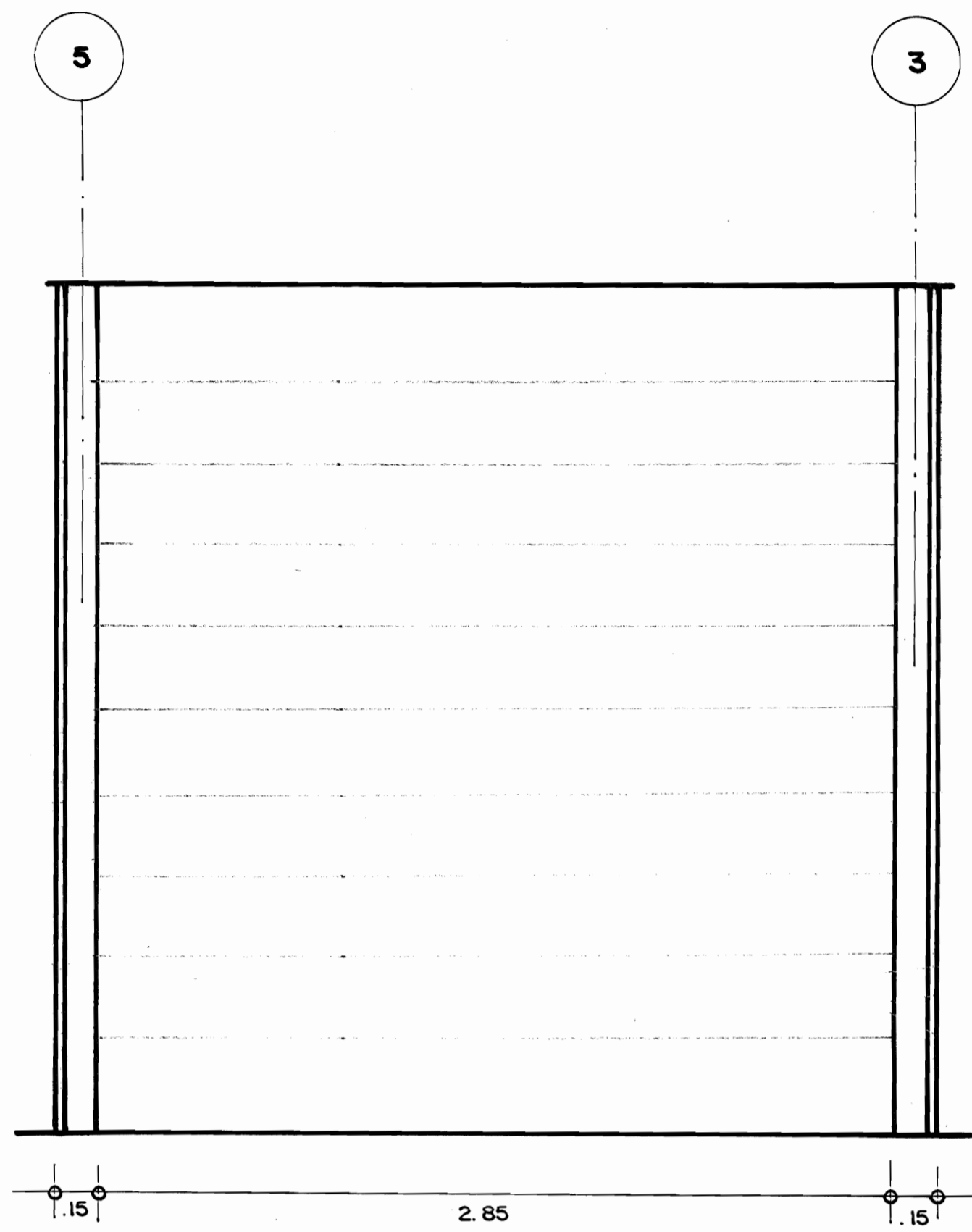

PLANO MUSEOGRAFICO OESTE

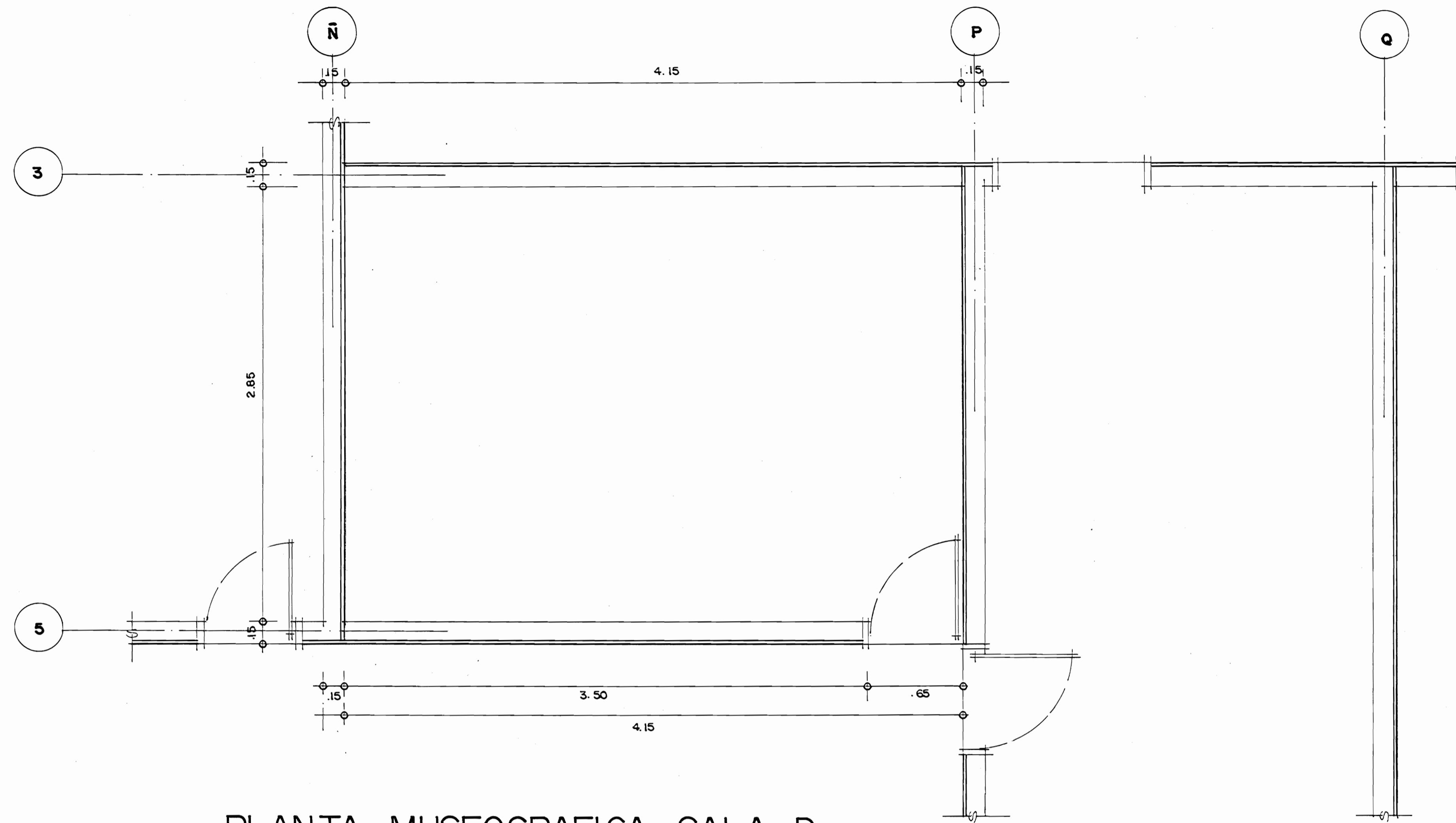

PLANTA MUSEOGRAFICA SALA D

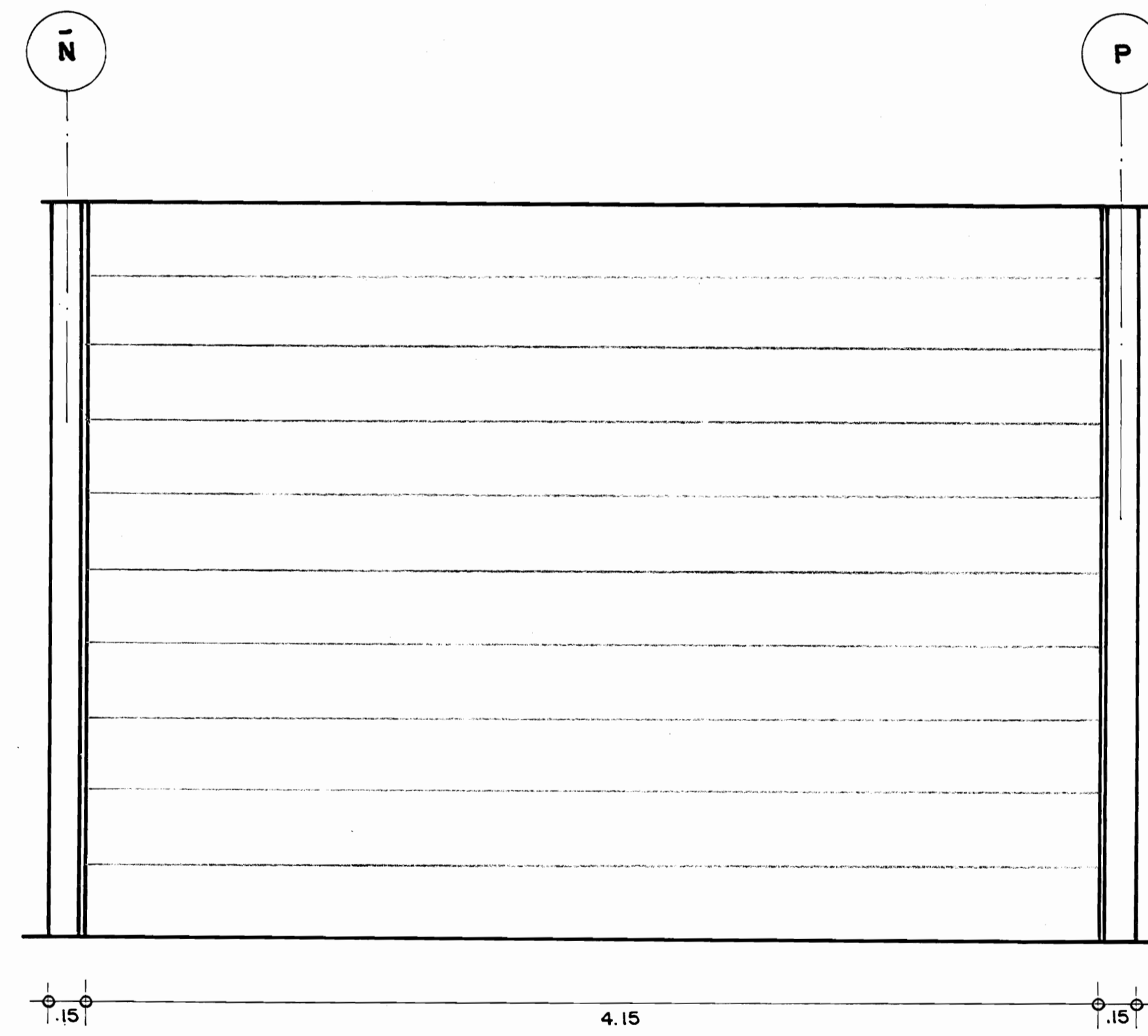

PLANO MUSEOGRAFICO NORTE

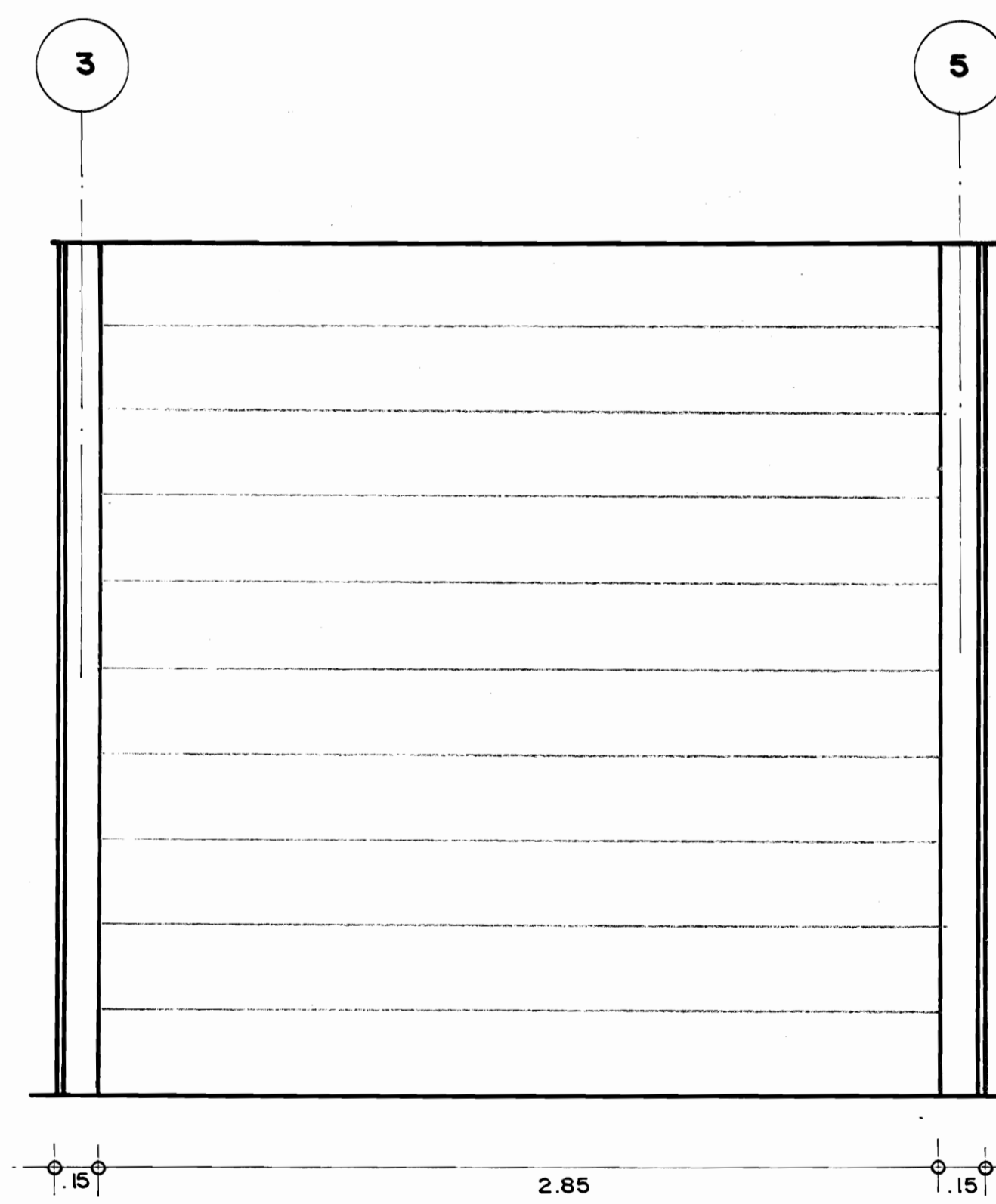

PLANO MUSEOGRAFICO ESTE

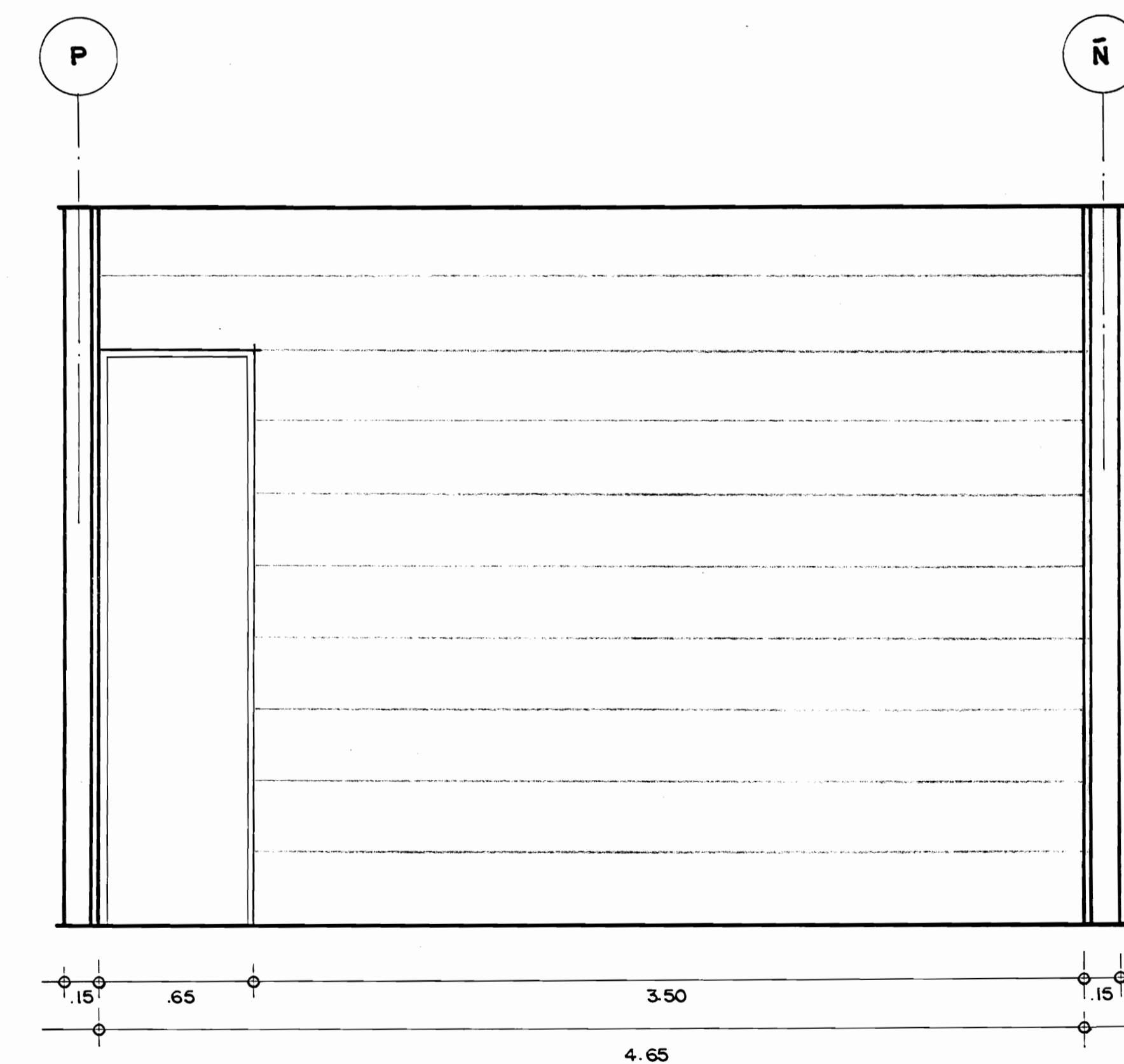

PLANO MUSEOGRAFICO SUR

PROYECTO		
MUSEO HISTORICO SANTA ROSA		
CONTENIDO		
PLANTA Y ABATIMIENTOS SALA D		
ESCALA	FECHA	LAMINA
1:20	ENERO 1988	14

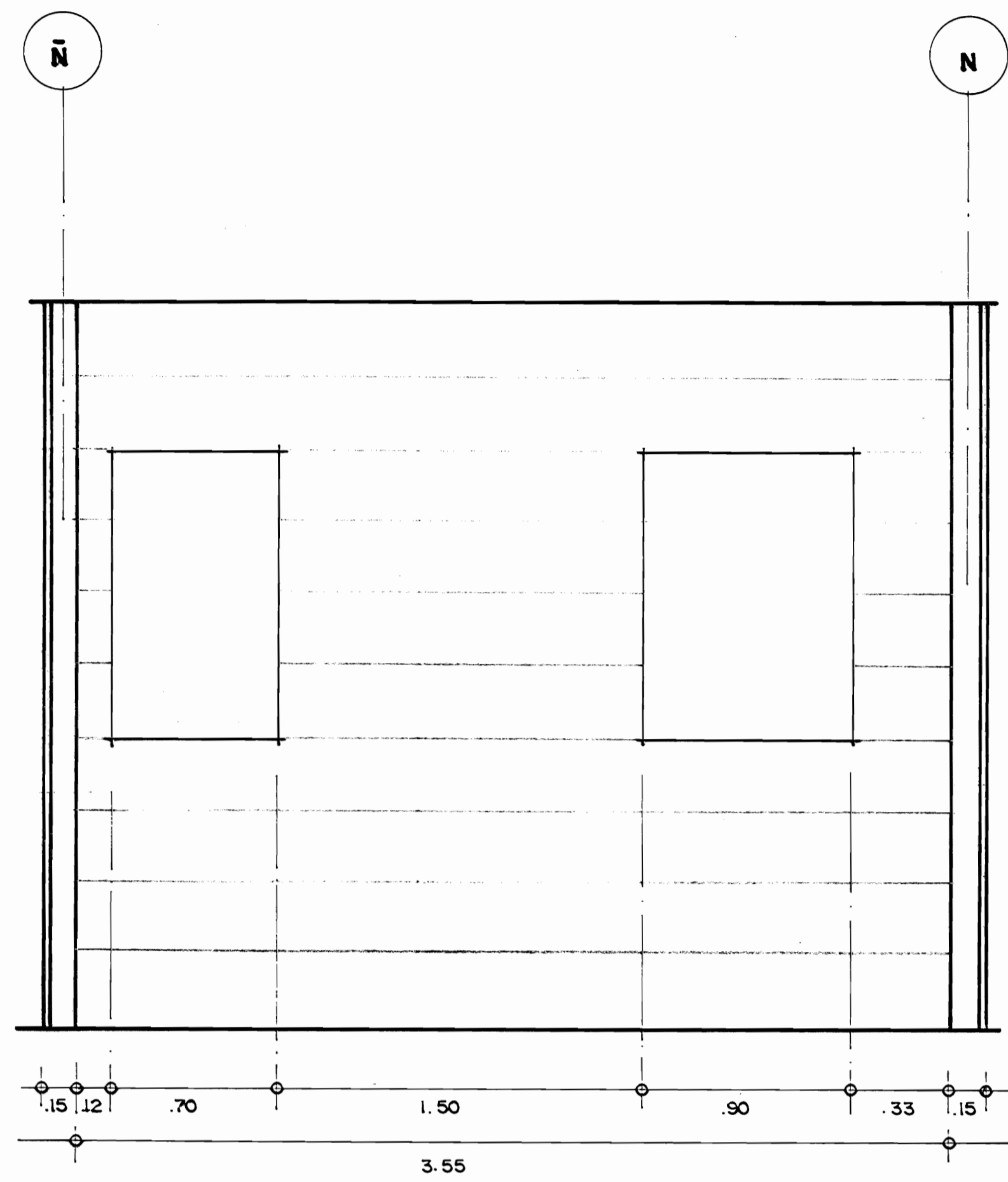

PLANO MUSEOGRAFICO SUR

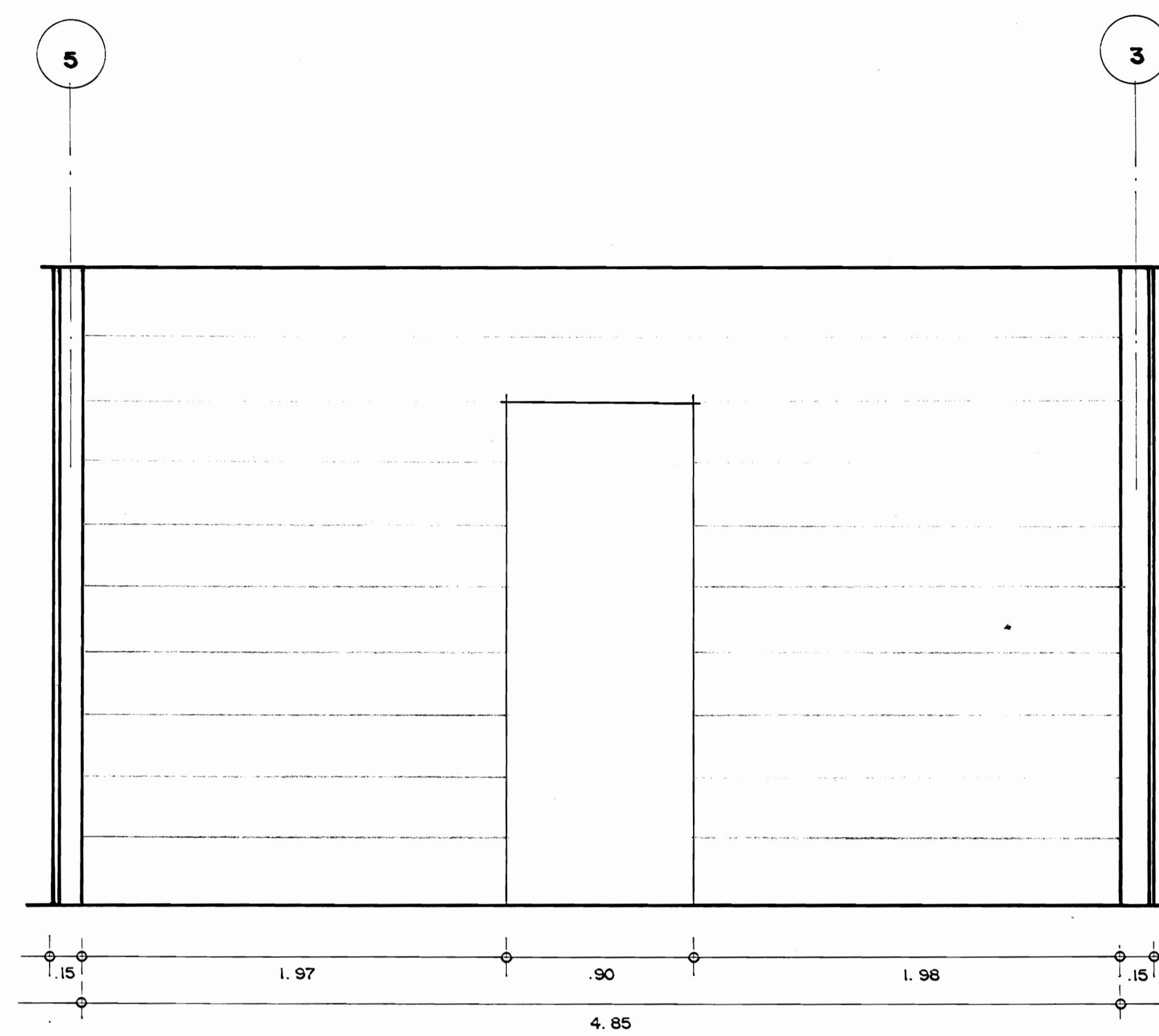

PLANO MUSEOGRAFICO OESTE

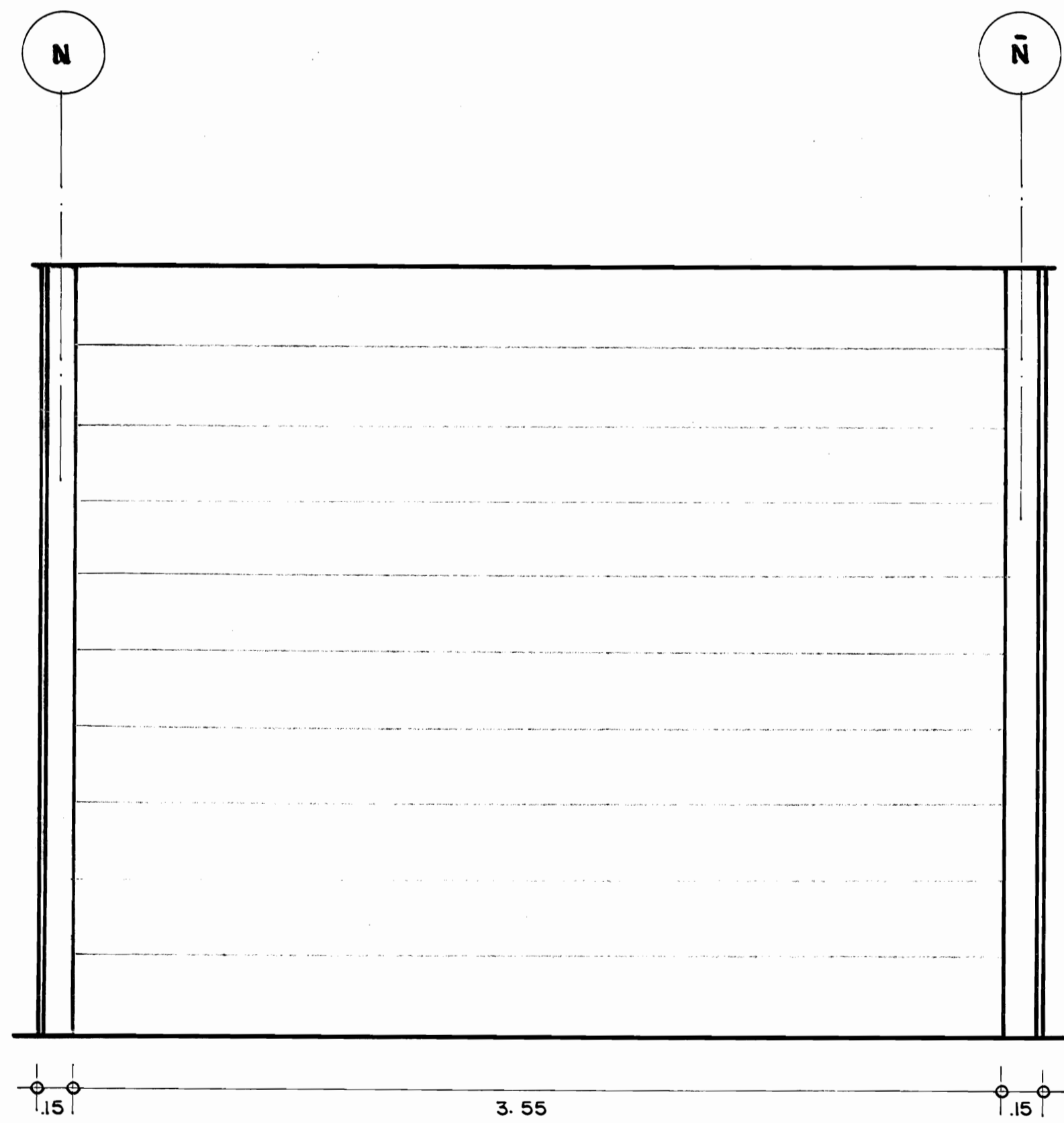

PLANO MUSEOGRAFICO NORTE

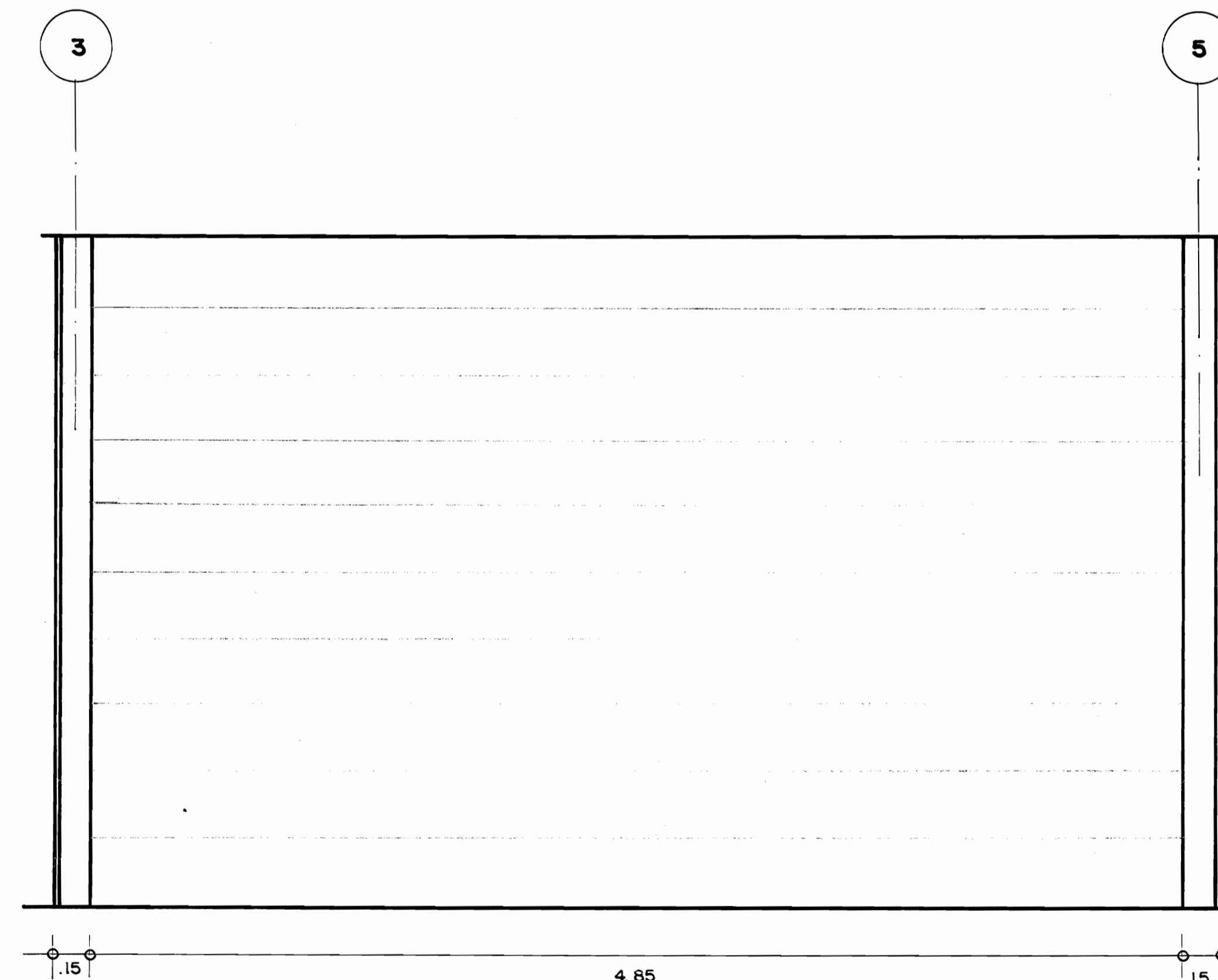

PLANO MUSEOGRAFICO ESTE

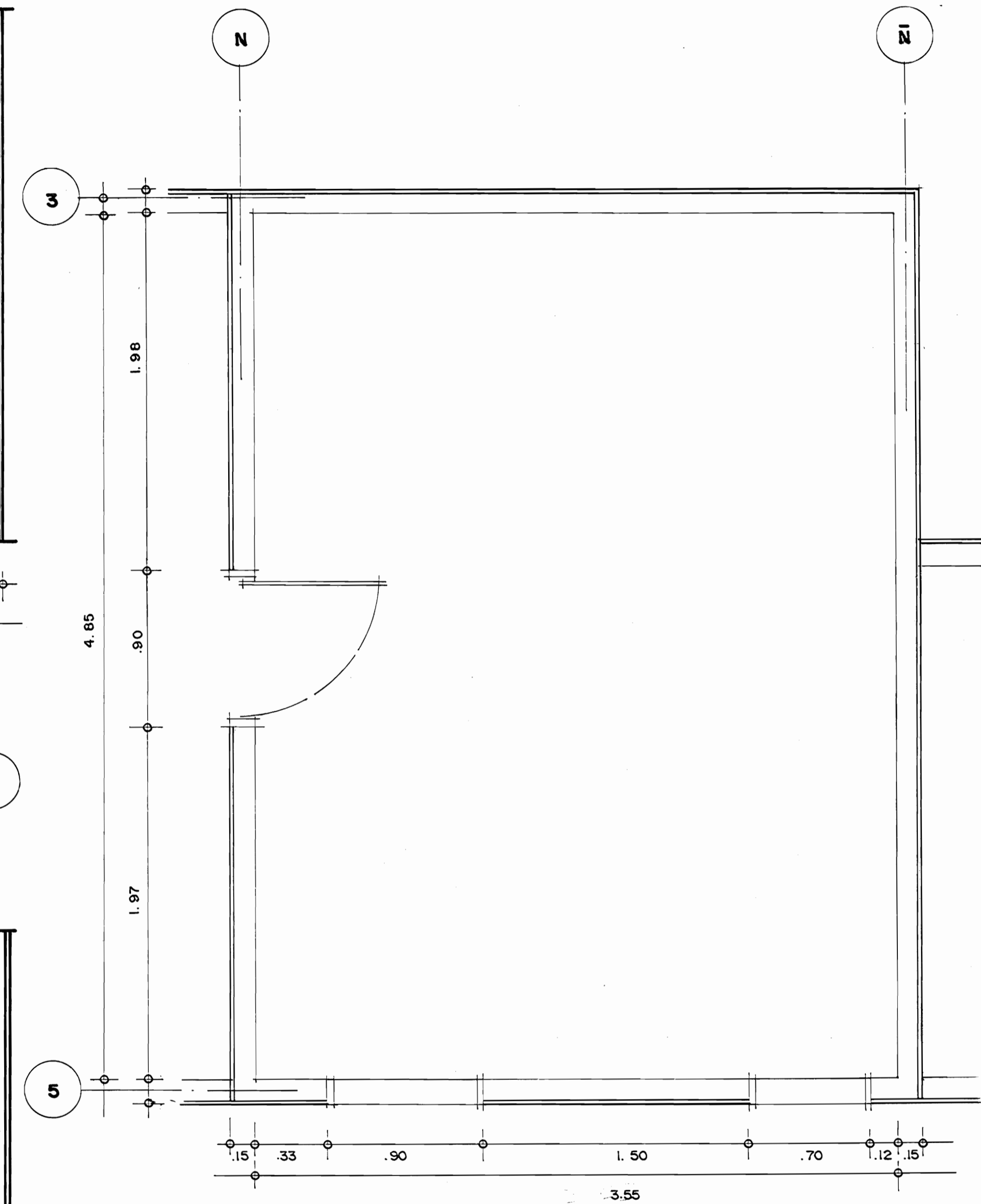

PLANTA MUSEOGRAFICA SALA E

PROYECTO  
MUSEO HISTORICO SANTA ROSA

CONTENIDO  
PLANTA Y ABATIMIENTOS  
SALA E

ESCALA	FECHA	LAMINA
1: 20	ENERO 1988	15

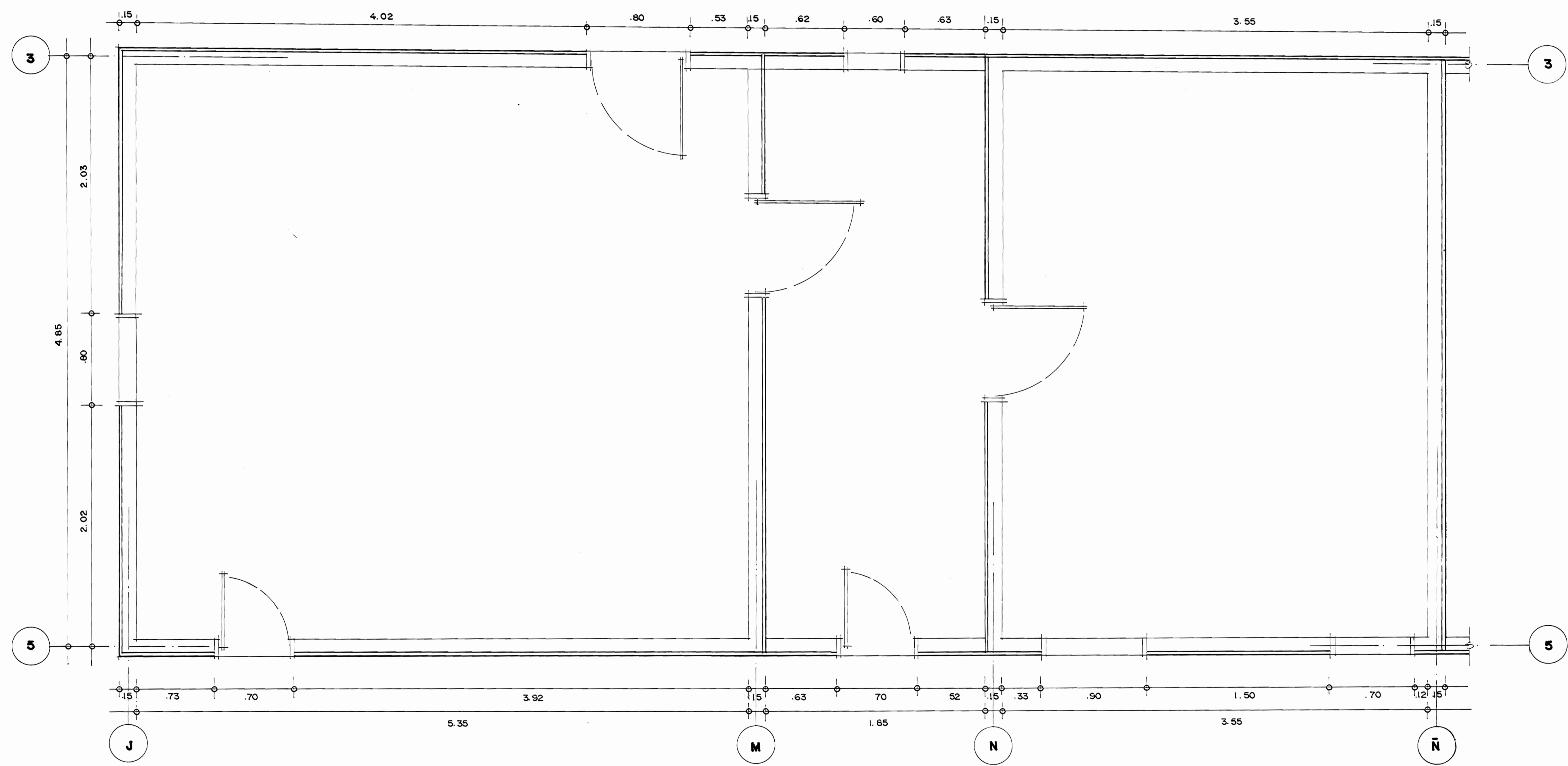

PLANTA MUSEOGRAFICA SALA G, SALA F Y SALA E

PROYECTO		
MUSEO HISTORICO SANTA ROSA		
CONTENIDO		
PLANTA MUSEOGRAFICA SALAS E, F Y G		
ESCALA	FECHA	LAMINA
1: 20	ENERO 1988	16



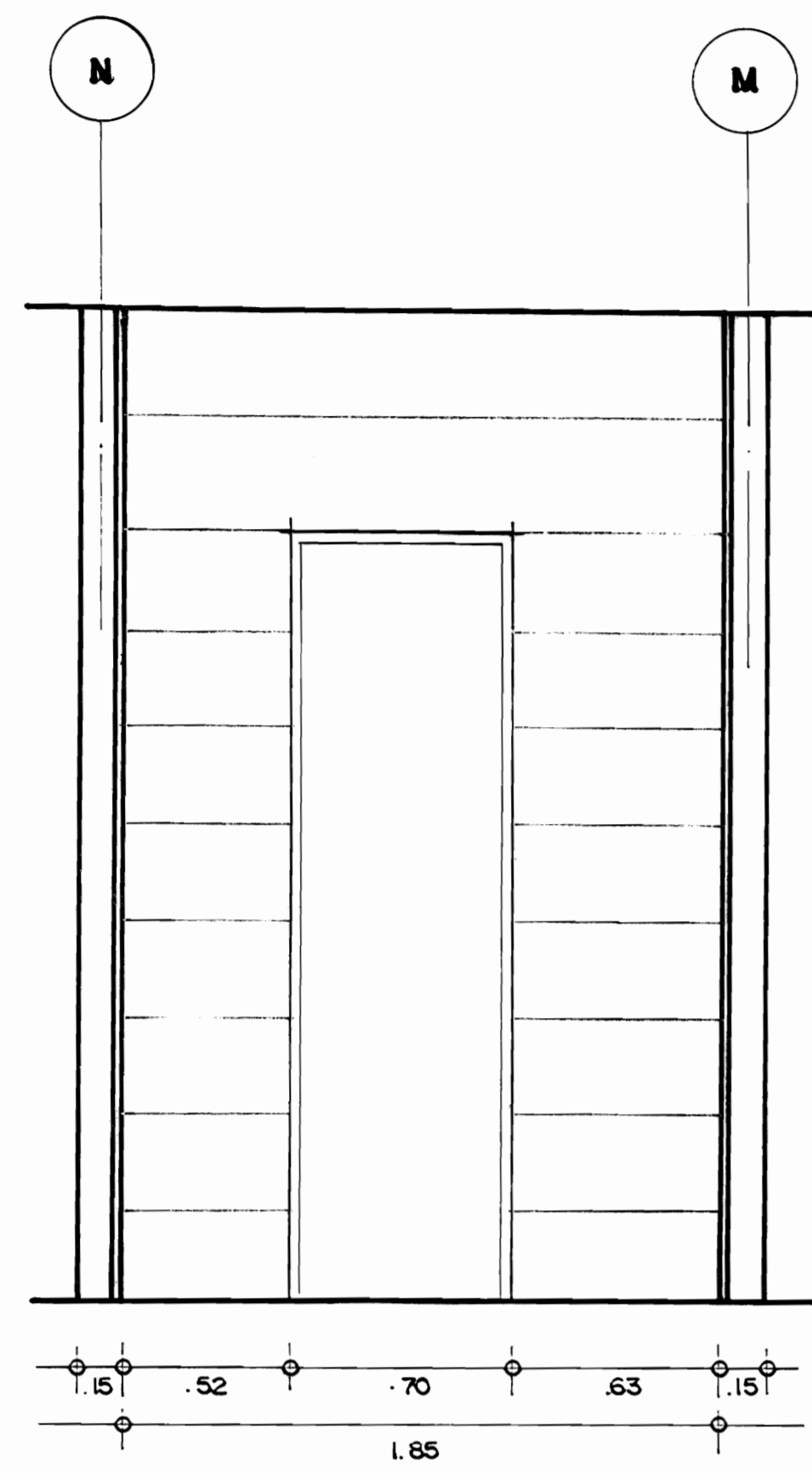

PLANO MUSEOGRAFICO SUR

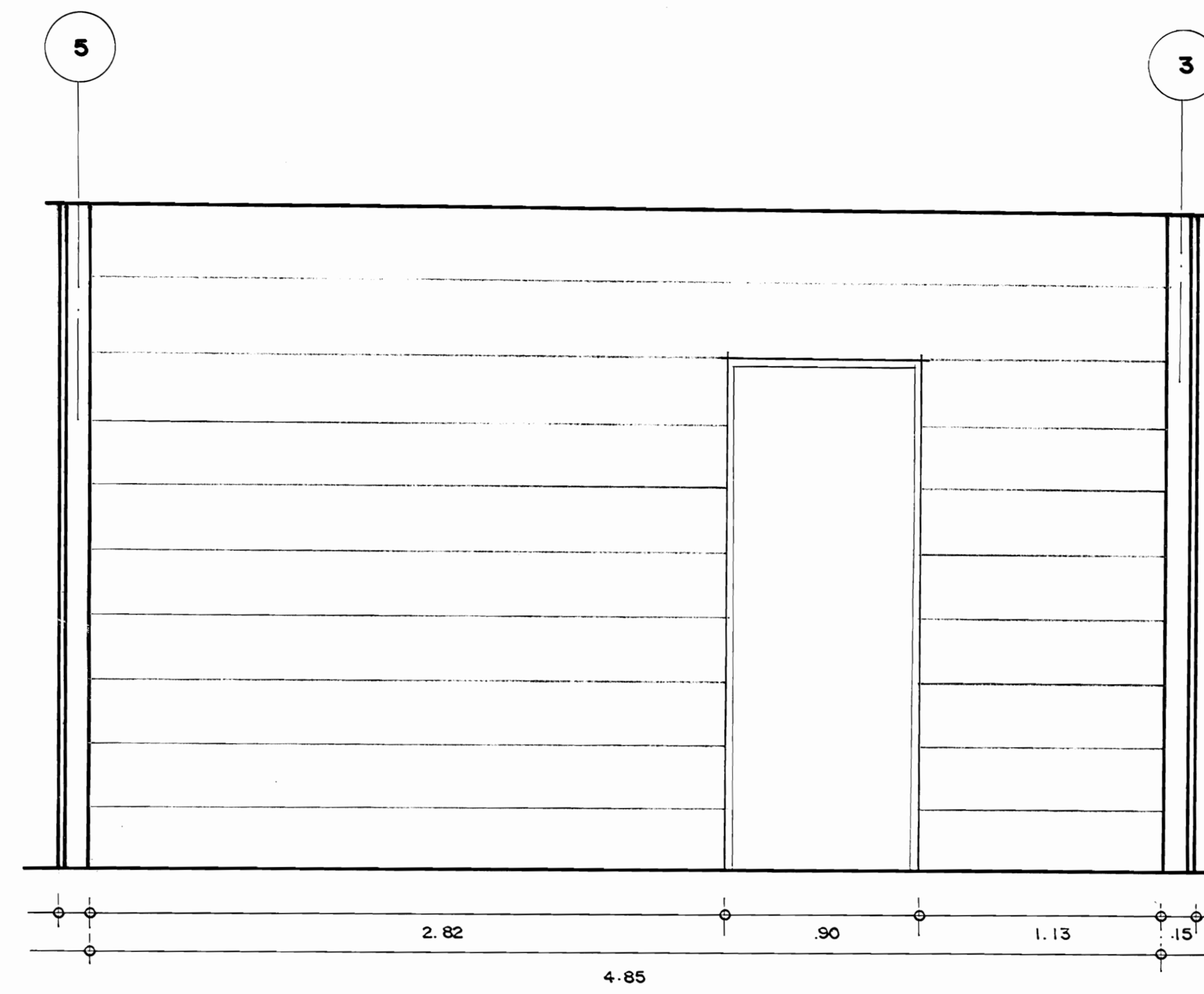

PLANO MUSEOGRAFICO OESTE

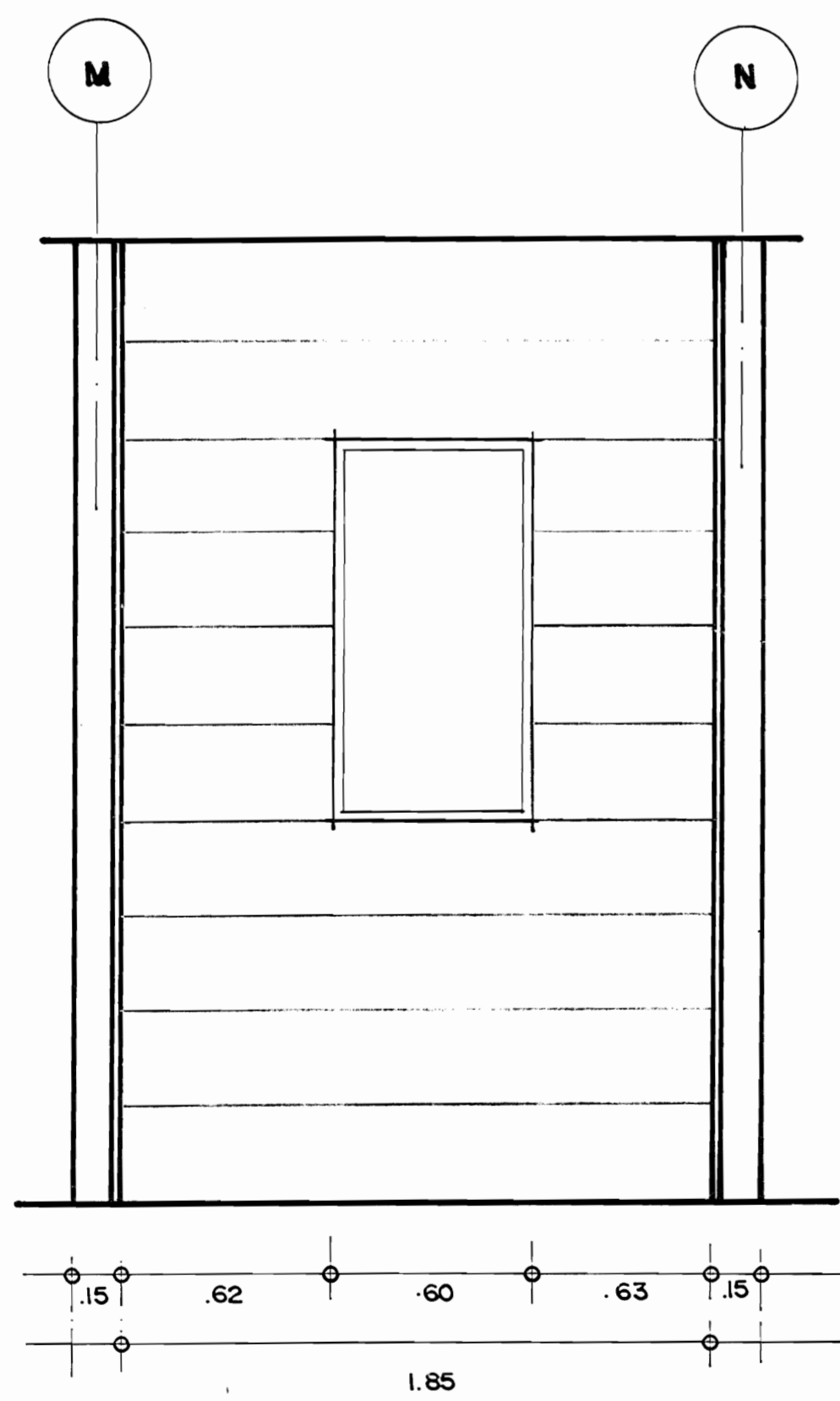

PLANO MUSEOGRAFICO NORTE

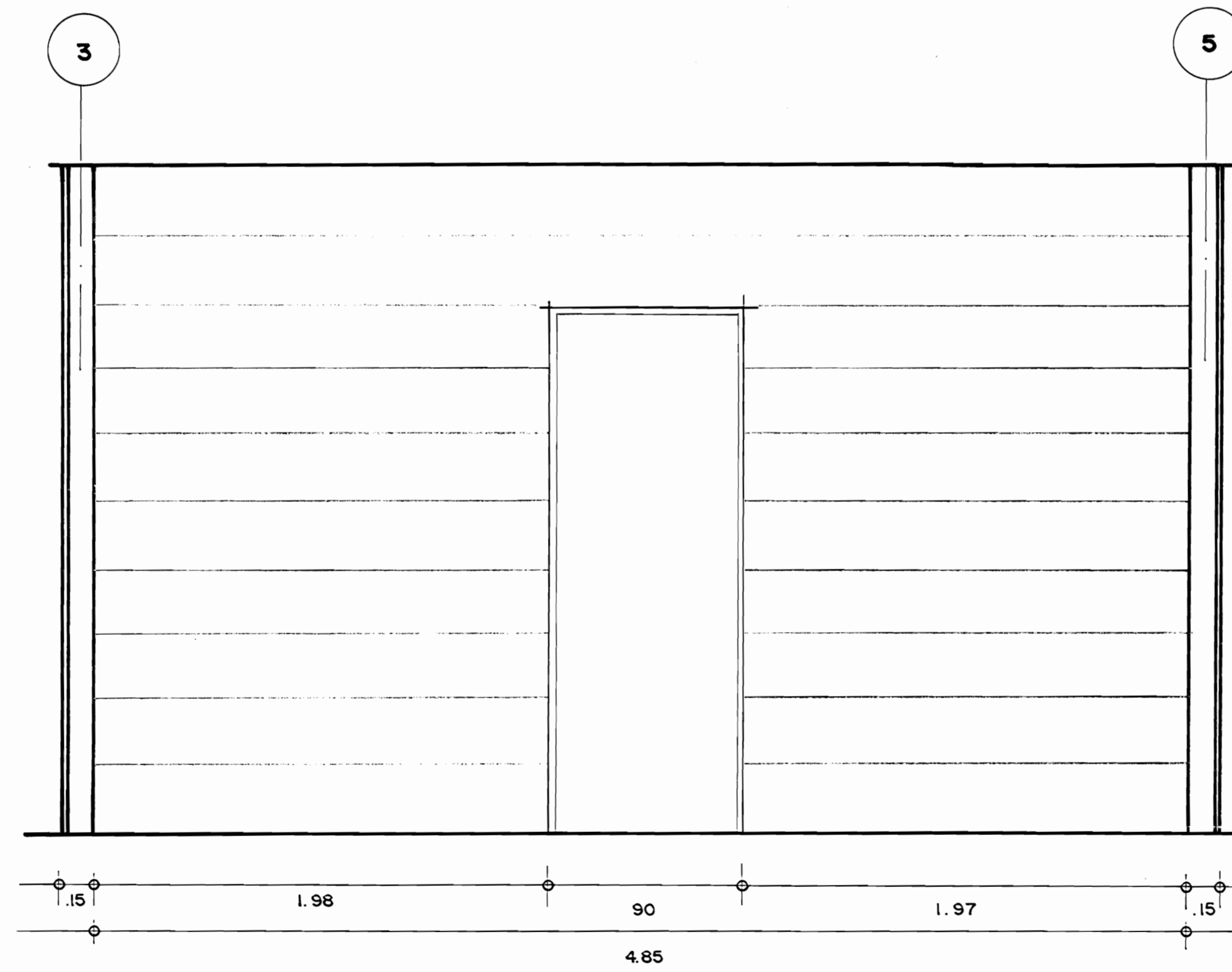

PLANO MUSEOGRAFICO ESTE

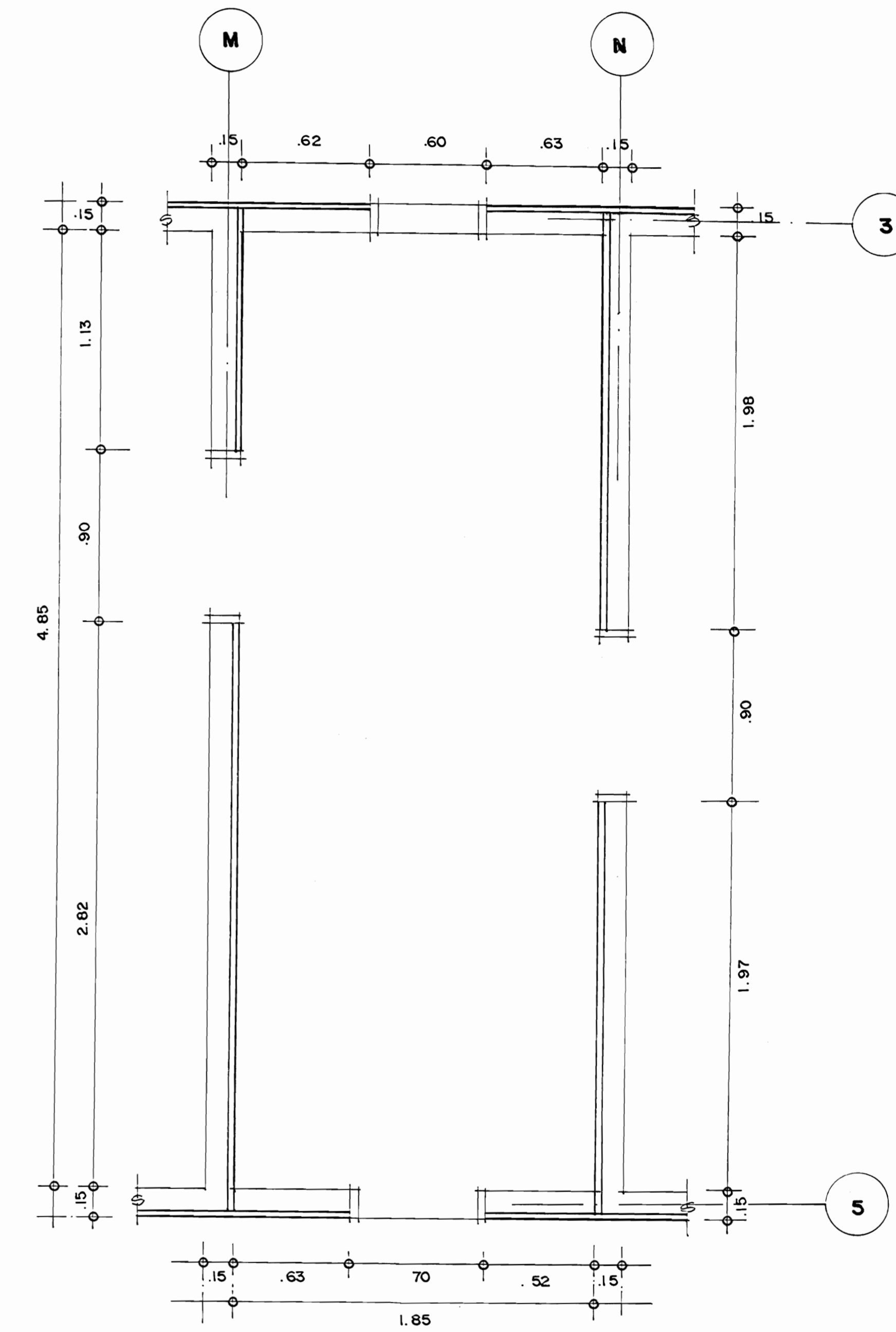

PLANTA MUSEOGRAFICA SALA F

PROYECTO		
MUSEO HISTORICO SANTA ROSA		
CONTENIDO		
PLANTA Y ABATIMIENTOS		
SALA F		
ESCALA	FECHA	LAMINA
1:20	ENERO 1988	17

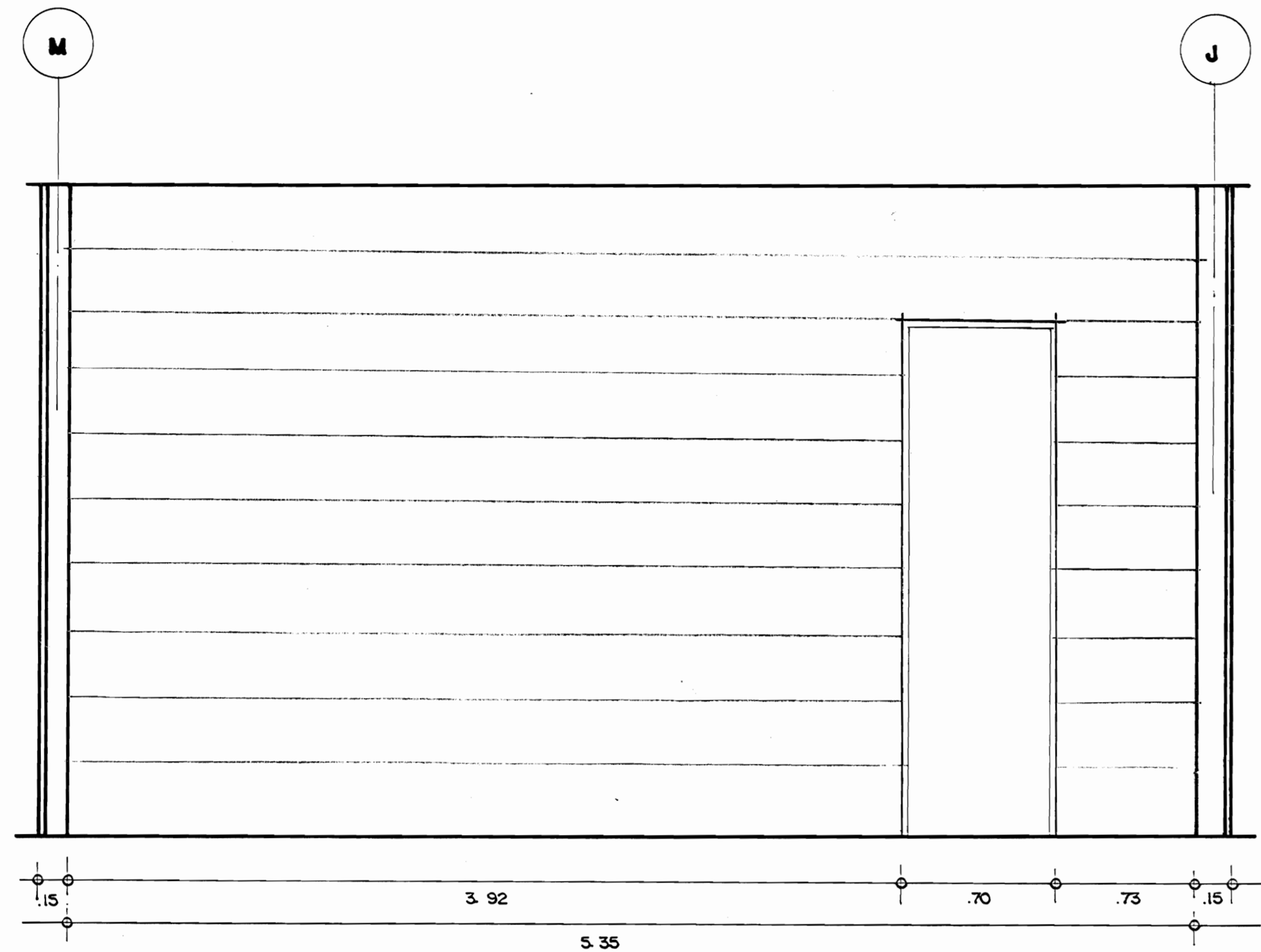

PLANO MUSEOGRAFICO SUR

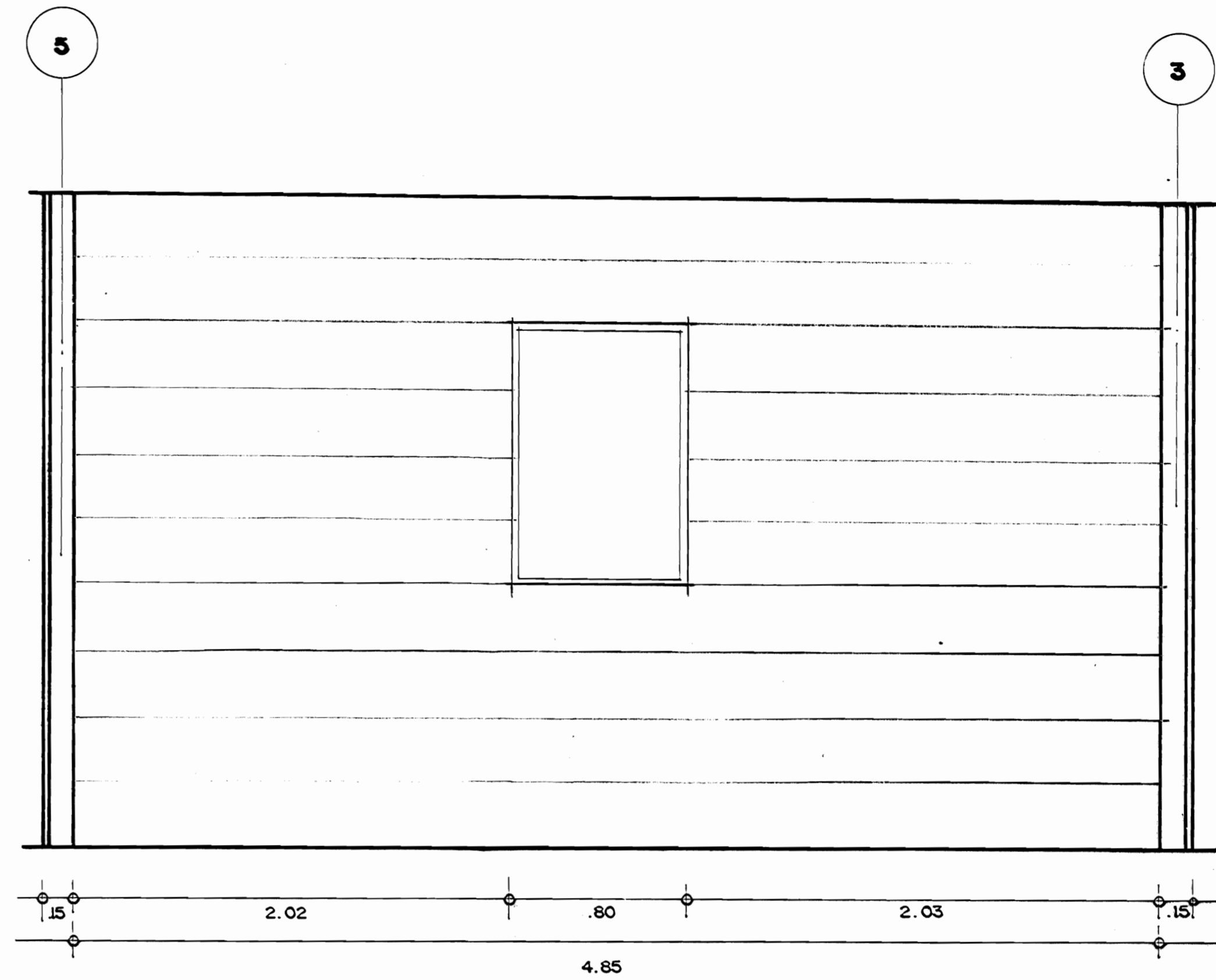

PLANO MUSEOGRAFICO OESTE

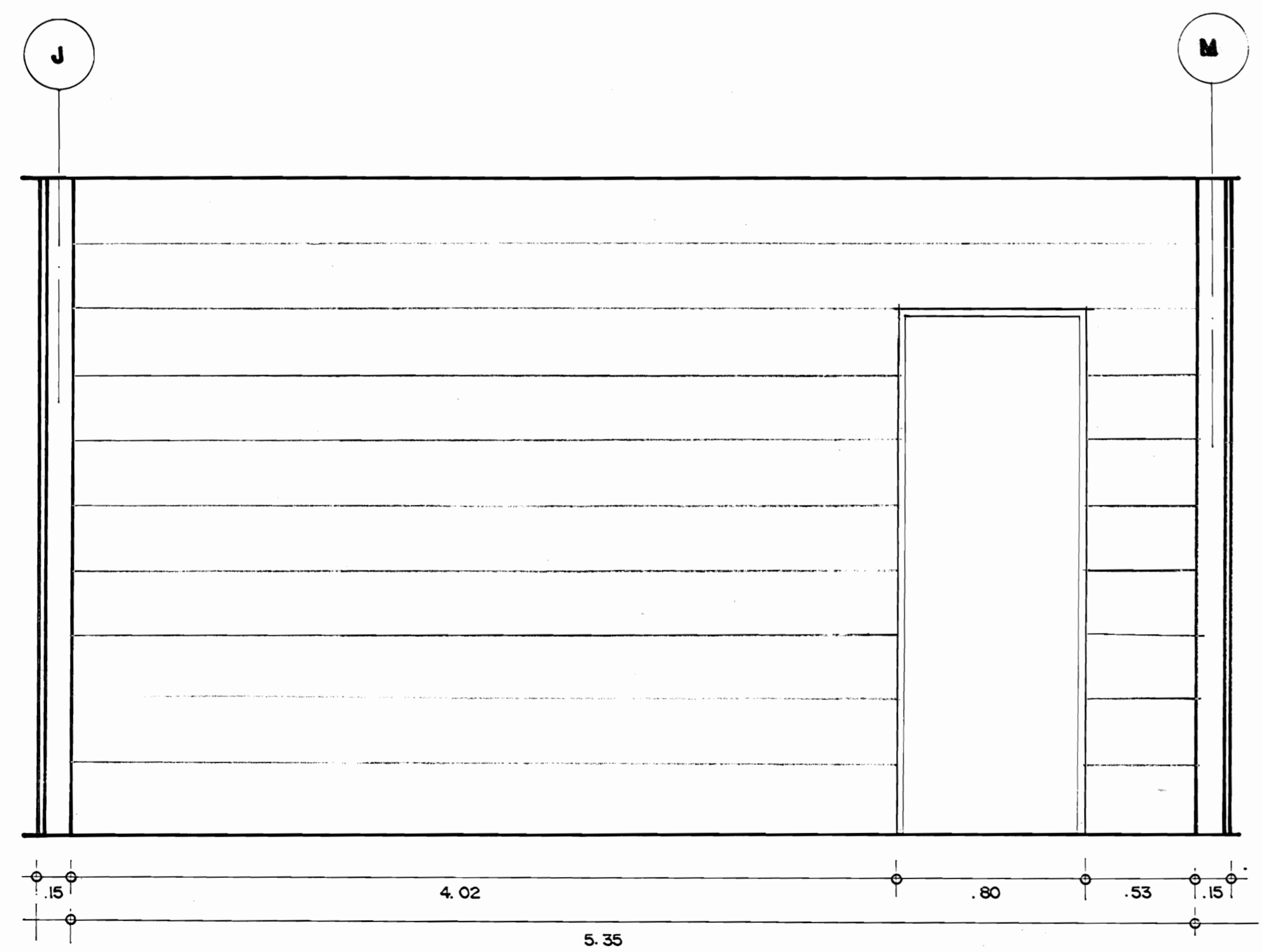

PLANO MUSEOGRAFICO NORTE

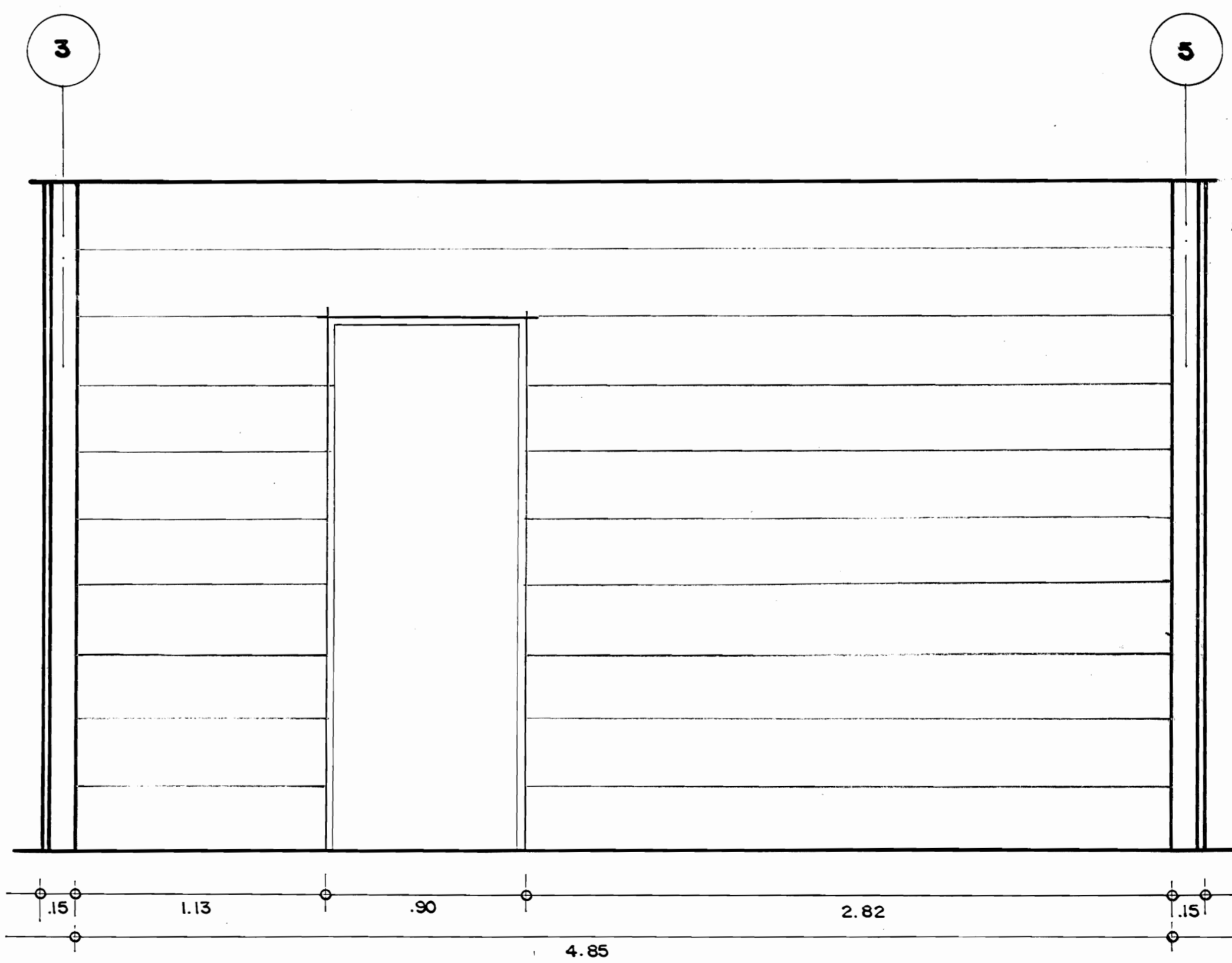

PLANO MUSEOGRAFICO ESTE

PROYECTO  
MUSEO HISTORICO SANTA ROSA

CONTENIDO  
LAMINA DE ABATIMIENTOS  
SALA G

ESCALA	FECHA	LAMINA
1:20	ENERO 1968	18