

**CORTE TRANSVERSAL ESTE** ESC. 1:75

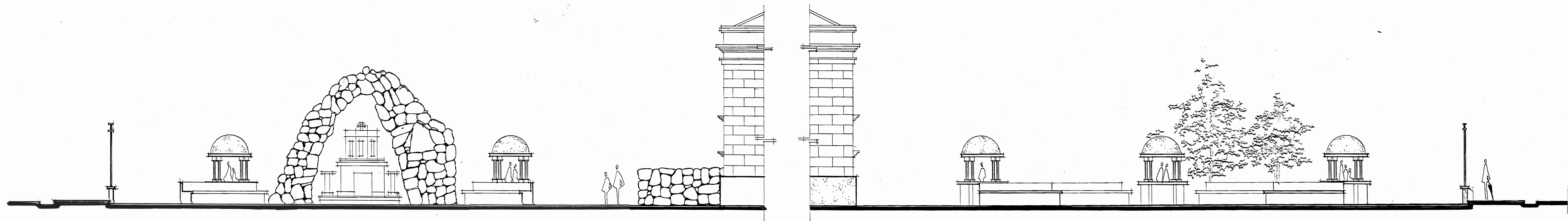

**JARDIN NORTE** ESC. 1:75

**JARDIN SUR** ESC. 1:75

UNIVERSIDAD DE COSTA RICA ESCUELA DE ARQUITECTURA		
LEVANTAMIENTO IGLESIA SAN JOAQUIN DE FLORES		
HEREDIA	CENTRO	SN JOAQUIN
INTEGRANTES:		
ALLAN ALFARO ARIAS ROLANDO CHAVES C.		
CONTENIDO:		
CORTE TRANSVERSAL ESTE JARDINES NORTE Y SUR.		
ESCALA	FECHA	LAMINA
1:75	JUNIO 88	1/3

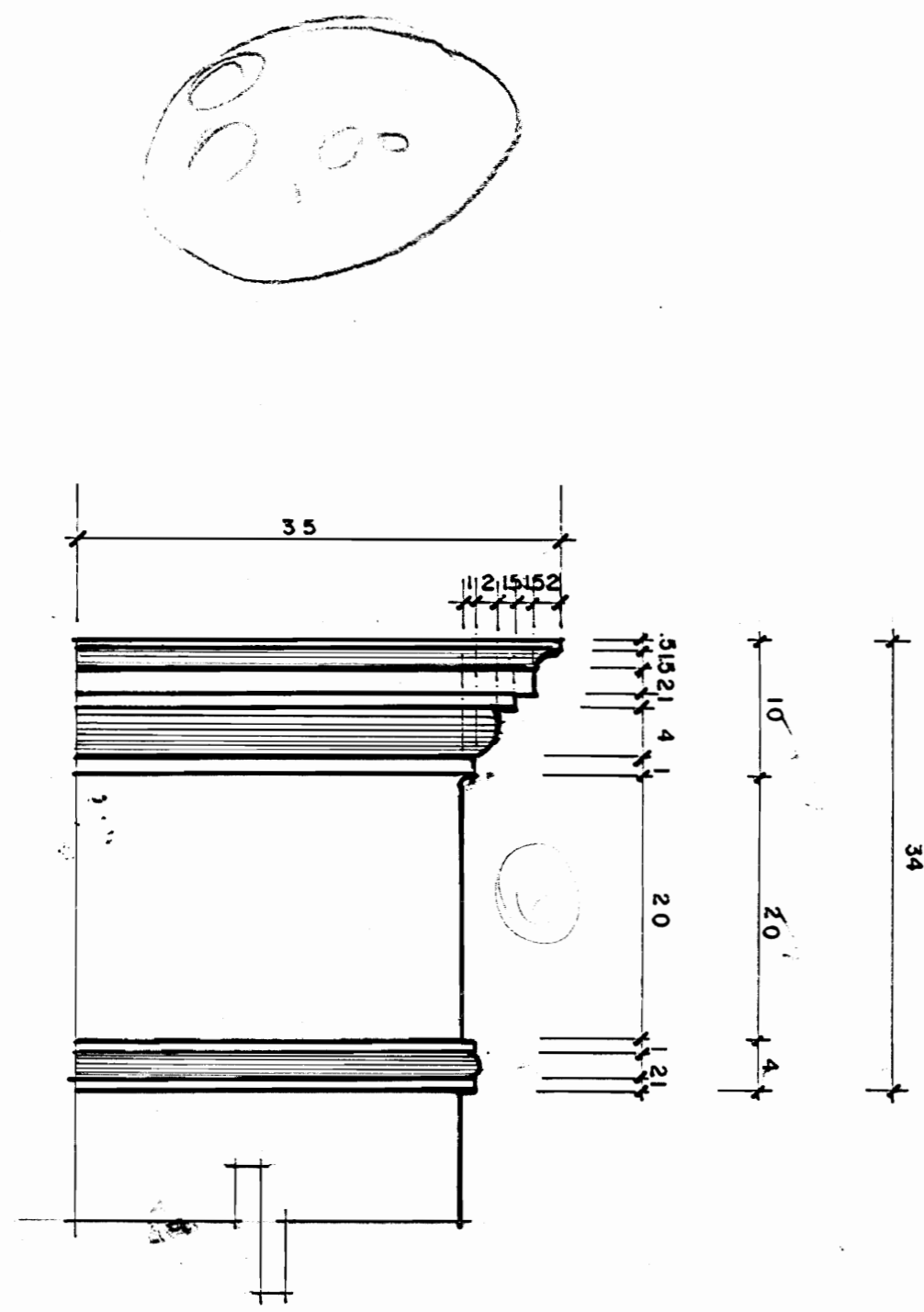

**DETALLE 6** ESC. 1:5

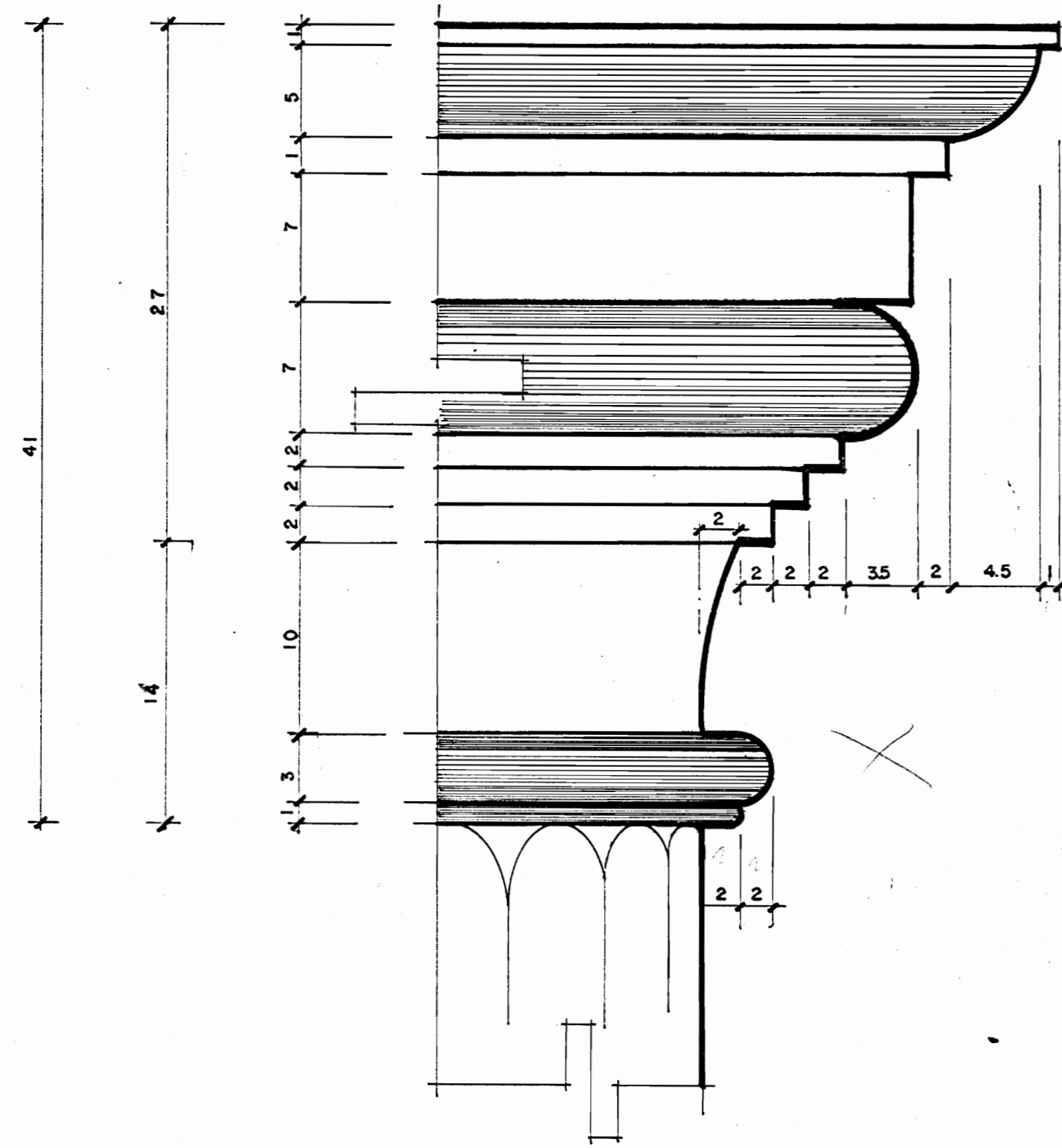

**DETALLE COLUMNA** ESC. 1:3

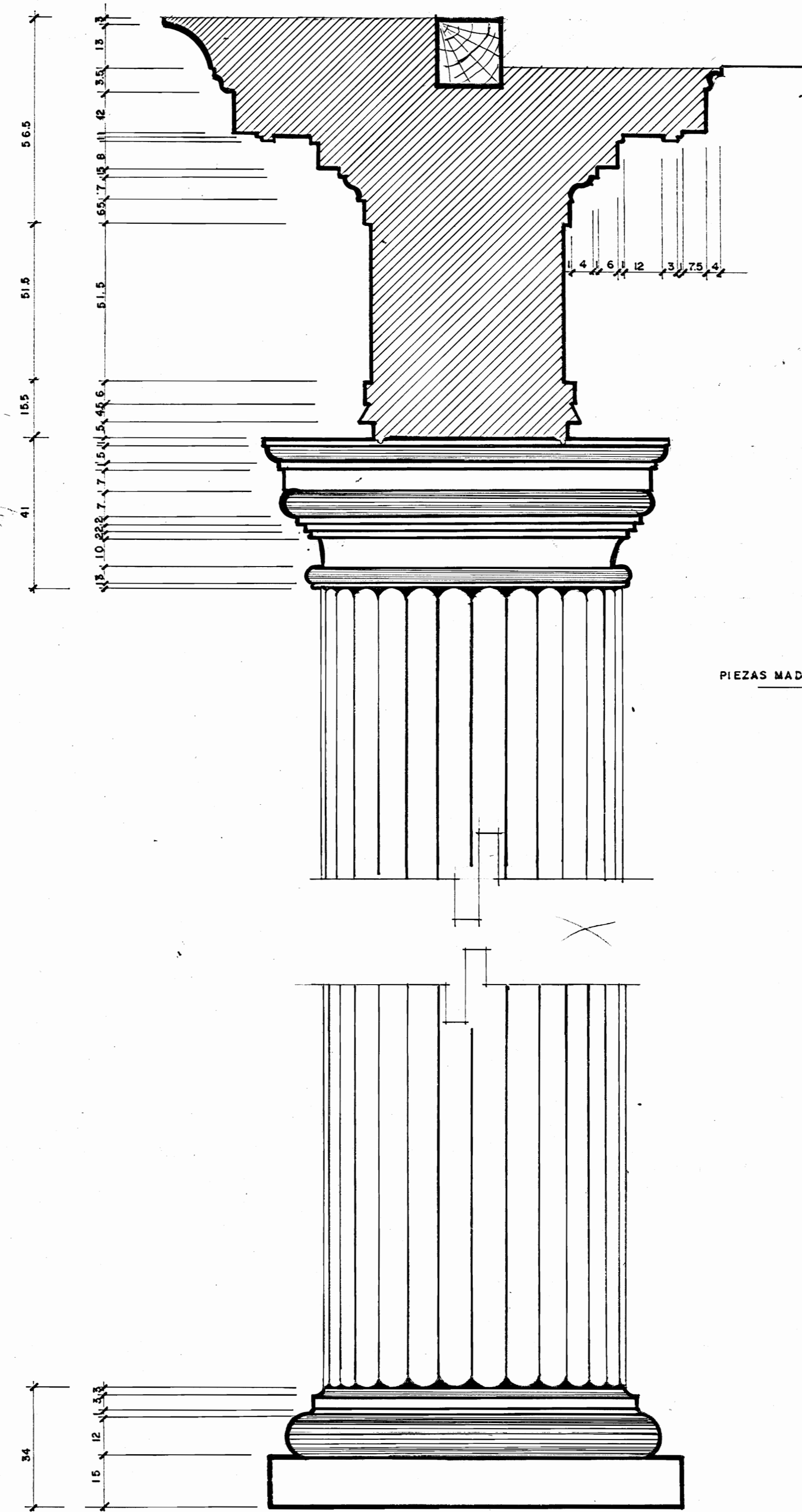

**DETALLE DE COLUMNA** ESC. 1:3

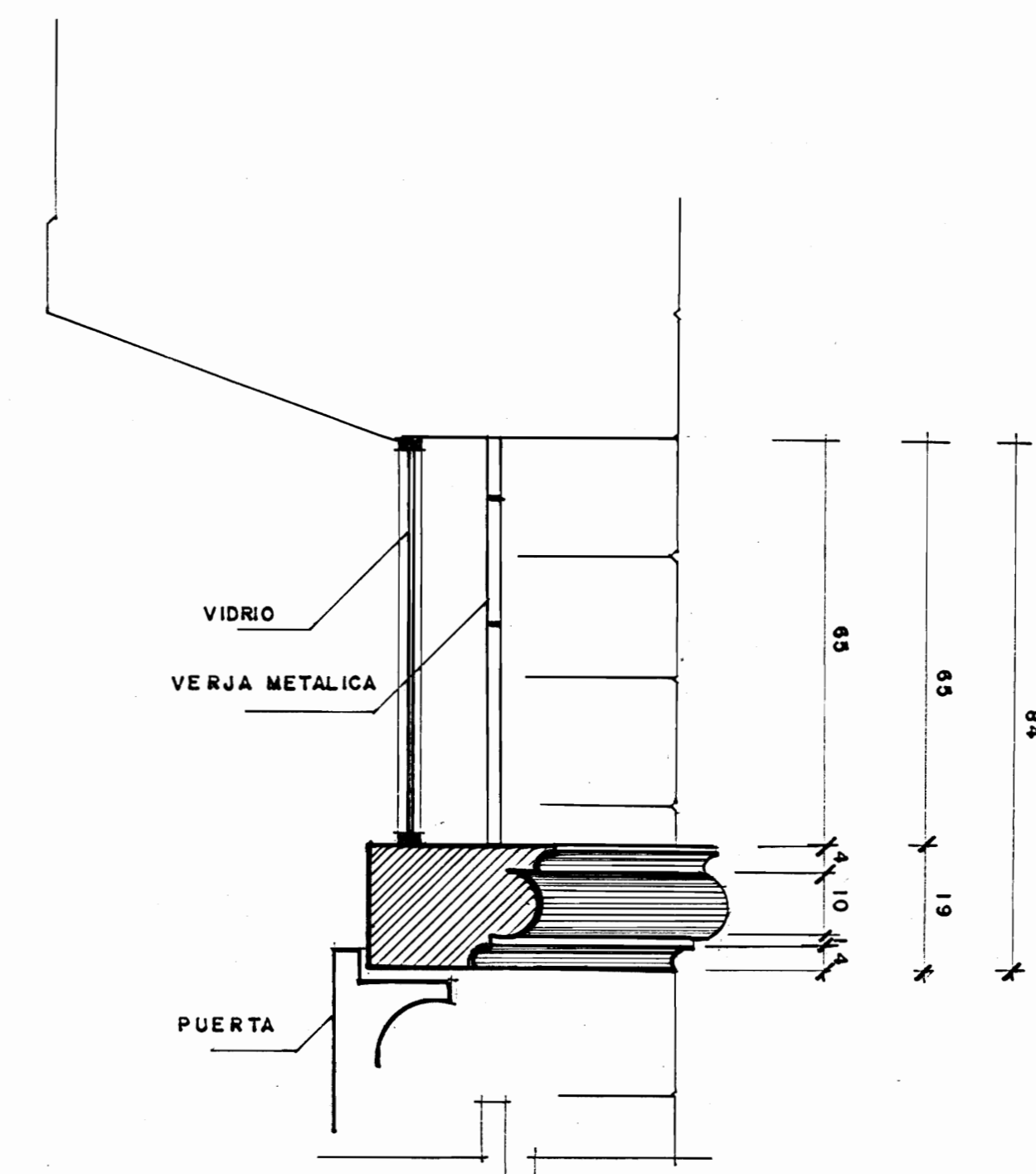

**DETALLE 7** ESC. 1:10

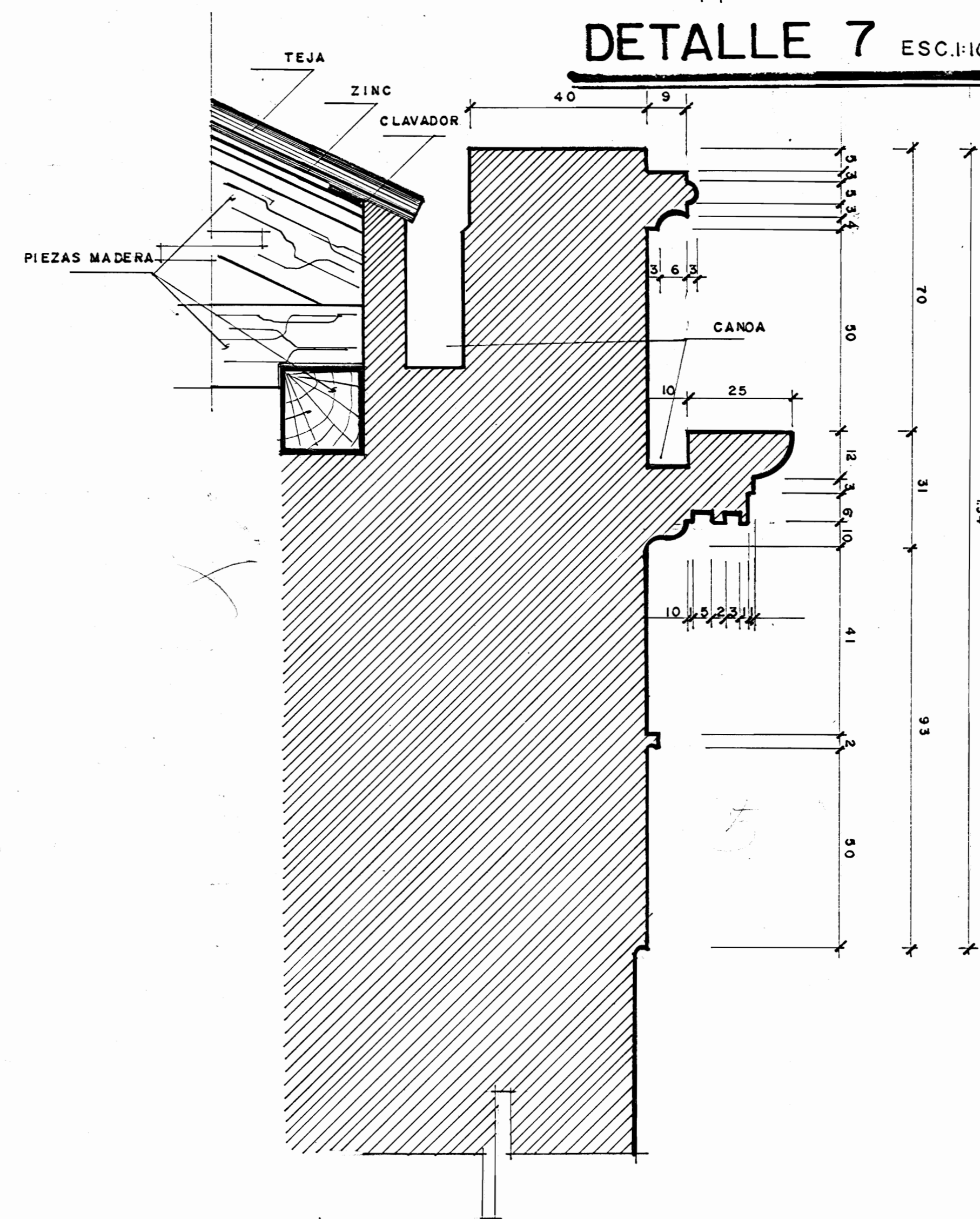

**DETALLE 5** ESC. 1:10

UNIVERSIDAD DE COSTA RICA ESCUELA DE ARQUITECTURA		
LEVANTAMIENTO IGLESIA SAN JOAQUIN DE FLORES		
HEREDIA	CENTRO	SAN JOAQUIN
<b>DXI</b>		
INTEGRANTES ROLANDO CHAVES C. ALLAN ALFARO A.		
CONTENIDO: DETALLES 5 - 6-7 Y COLUMNA		
ESCALA	FECHA	LAMINA
INDICADA	JUNIO 88	2 / 3

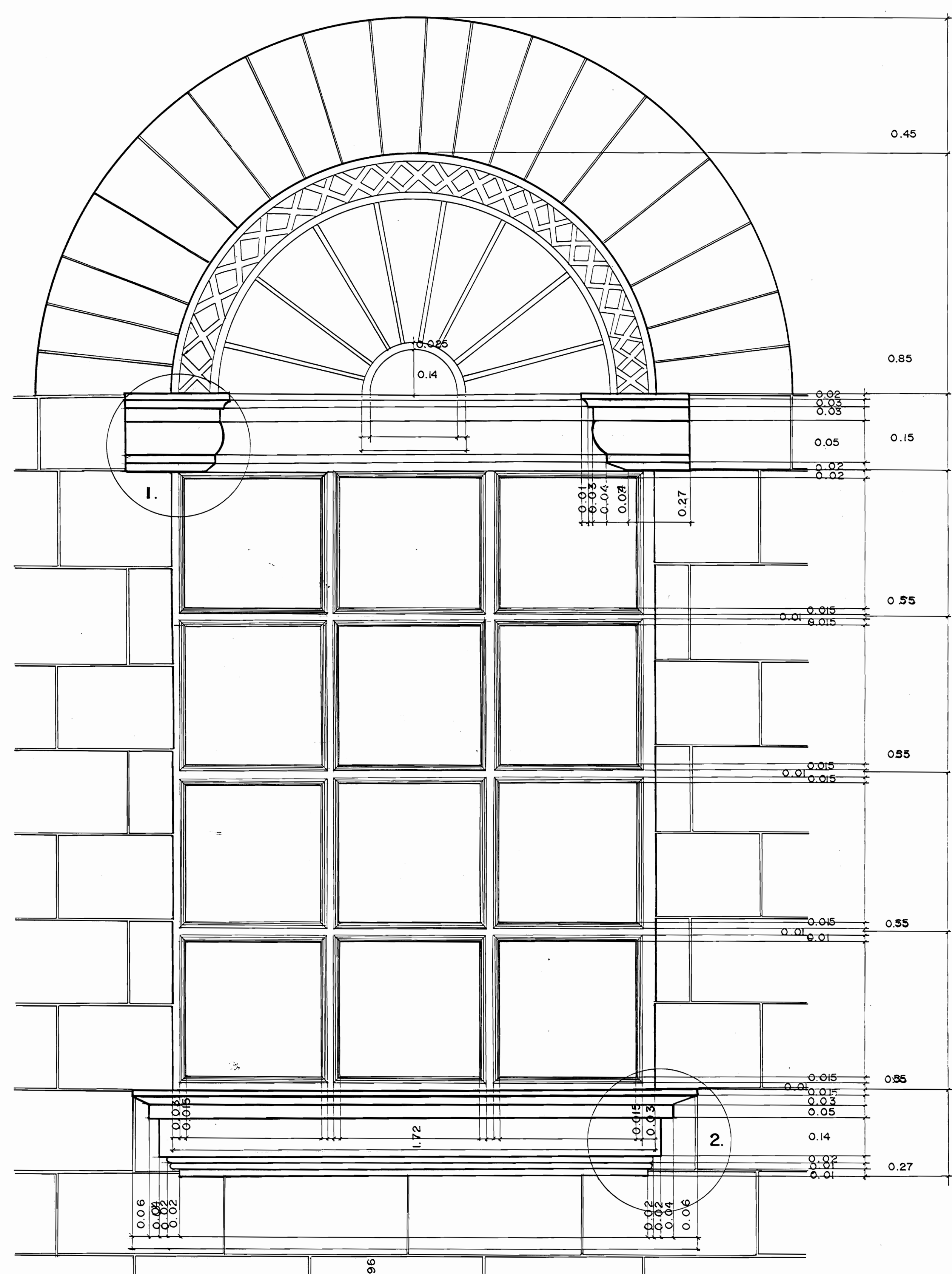

VENTANA CENTRAL \_ FACHADA POSTERIOR.  
escala: 1:10.

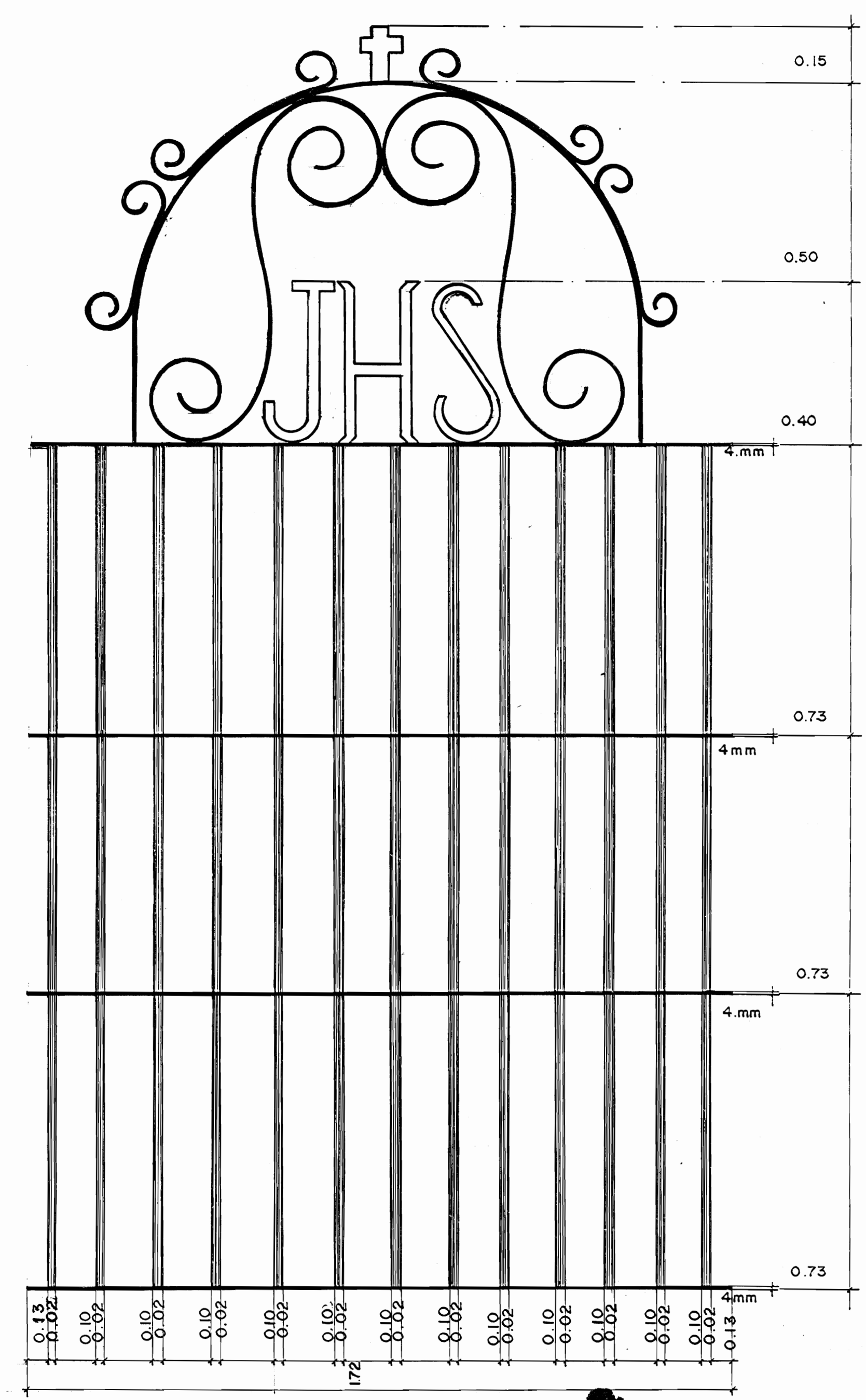

VERJA CENTRAL \_ FACHADA POSTERIOR.  
escala: 1:10.

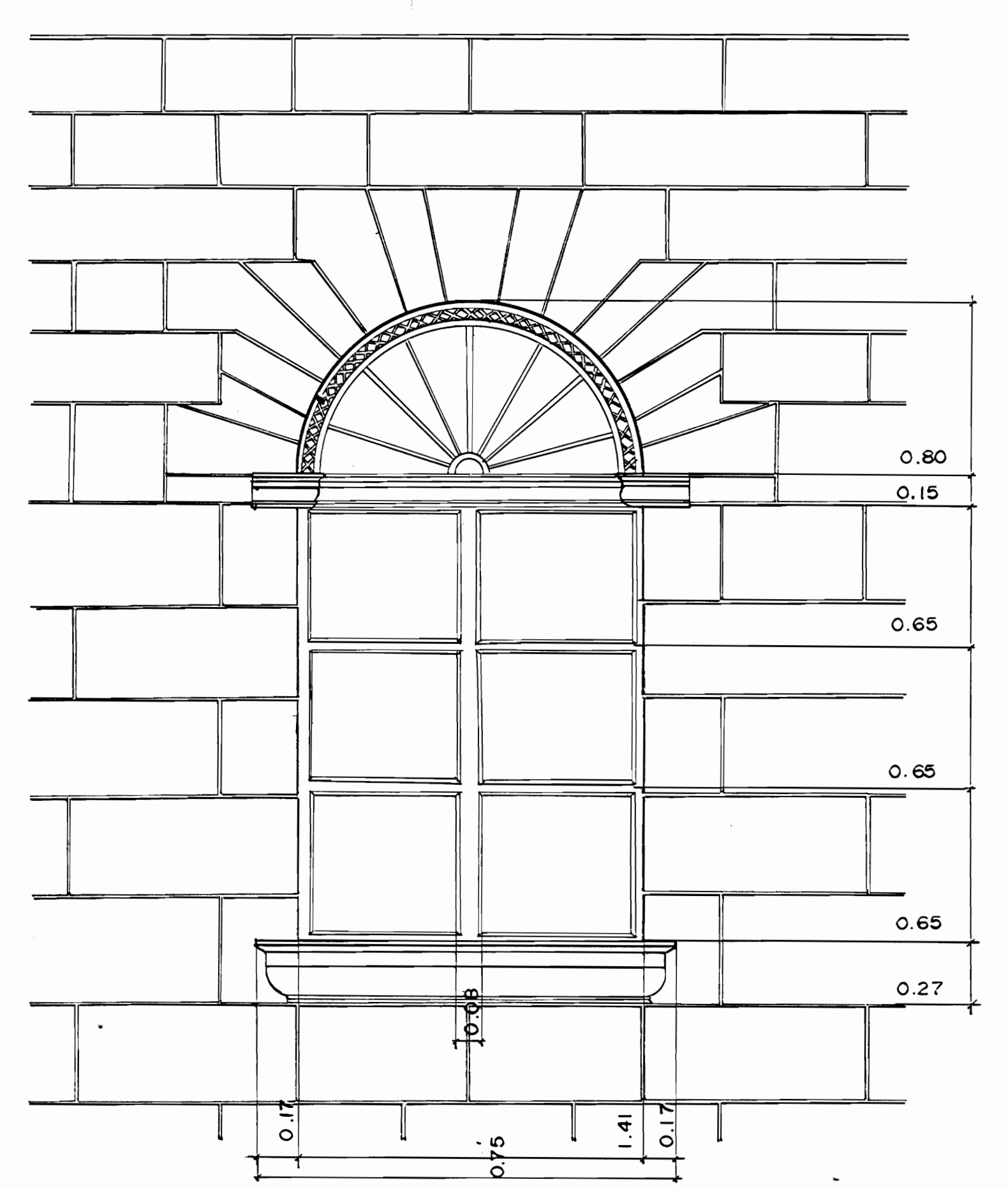

VENTANA LATERAL \_ FACHADA POST.  
escala: 1:20.

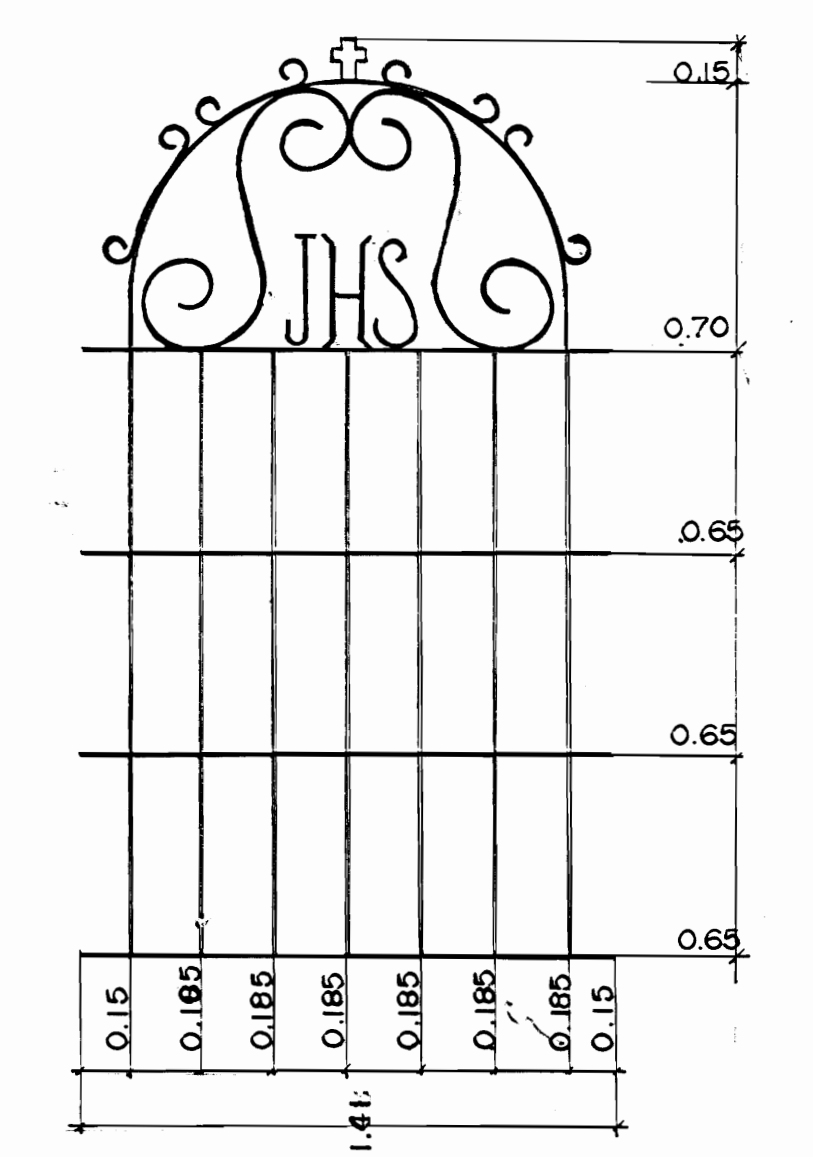

VERJA LATERAL \_ FACHADA POST.  
escala: 1:20.

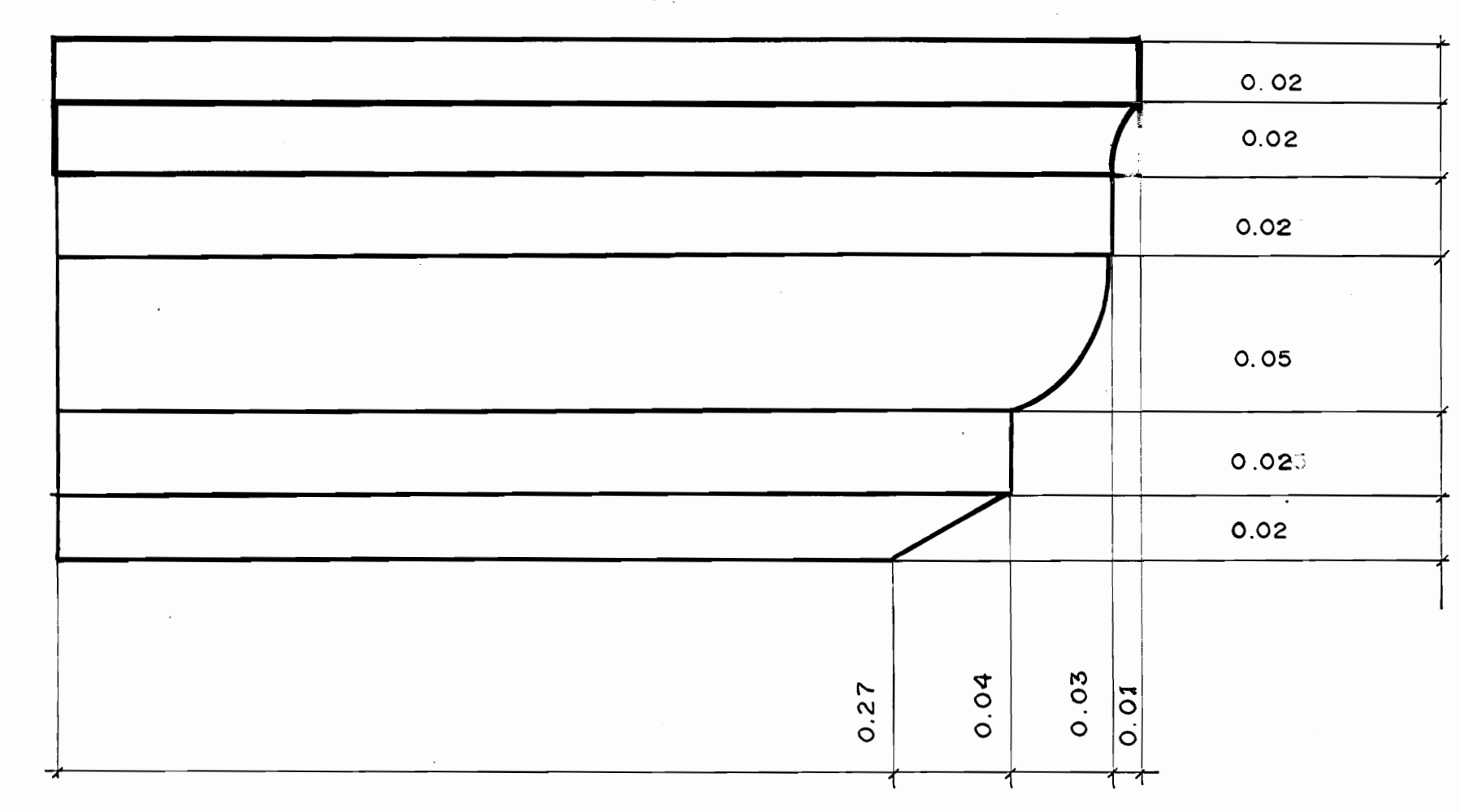

DETALLE 1.  
escala: 1:0.5

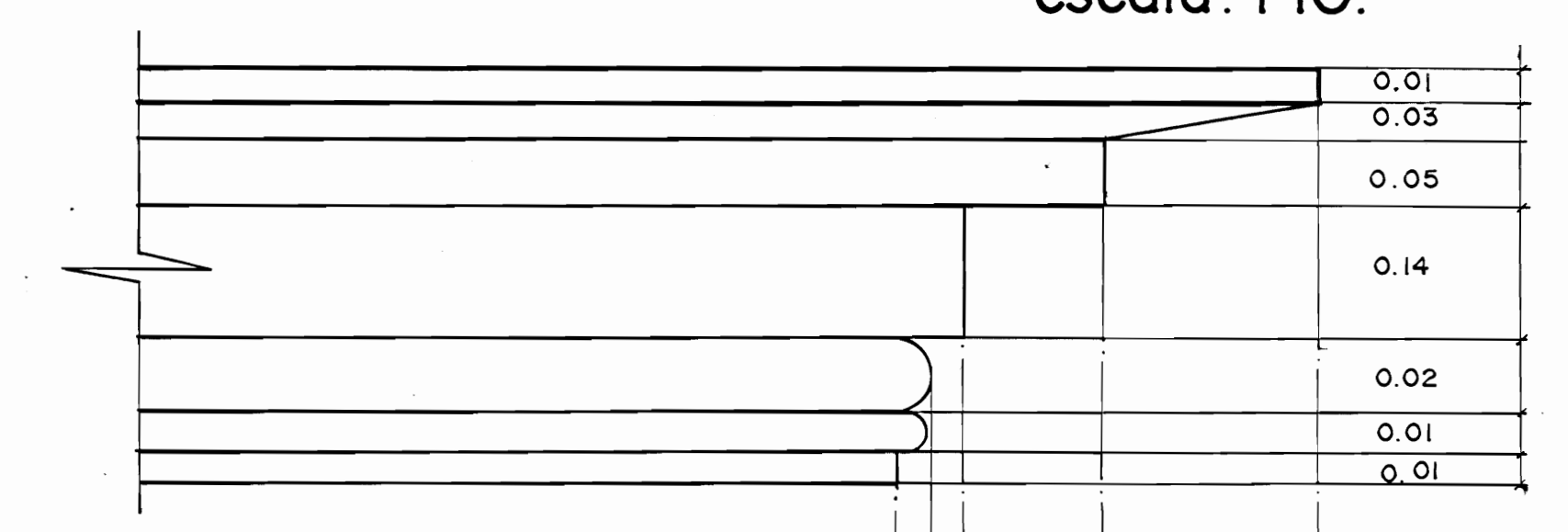

DETALLE 2.

UNIVERSIDAD DE COSTA RICA ESCUELA DE ARQUITECTURA.		
LEVANTAMIENTO IGLESIA SAN JOAQUIN DE FLORES.		
provincia:	cantón:	distrito:
Heredia.	Central.	San Joaquín.
INTEGRANTES:		
Reddy Bolaños M.		
Fernández M. Vera.		
Marco V. Solano S.		
CONTENIDO:		
DETALLES.		
ESCALA.	FECHA	LAMINA
INDICADA.	3 . 6 . 88	

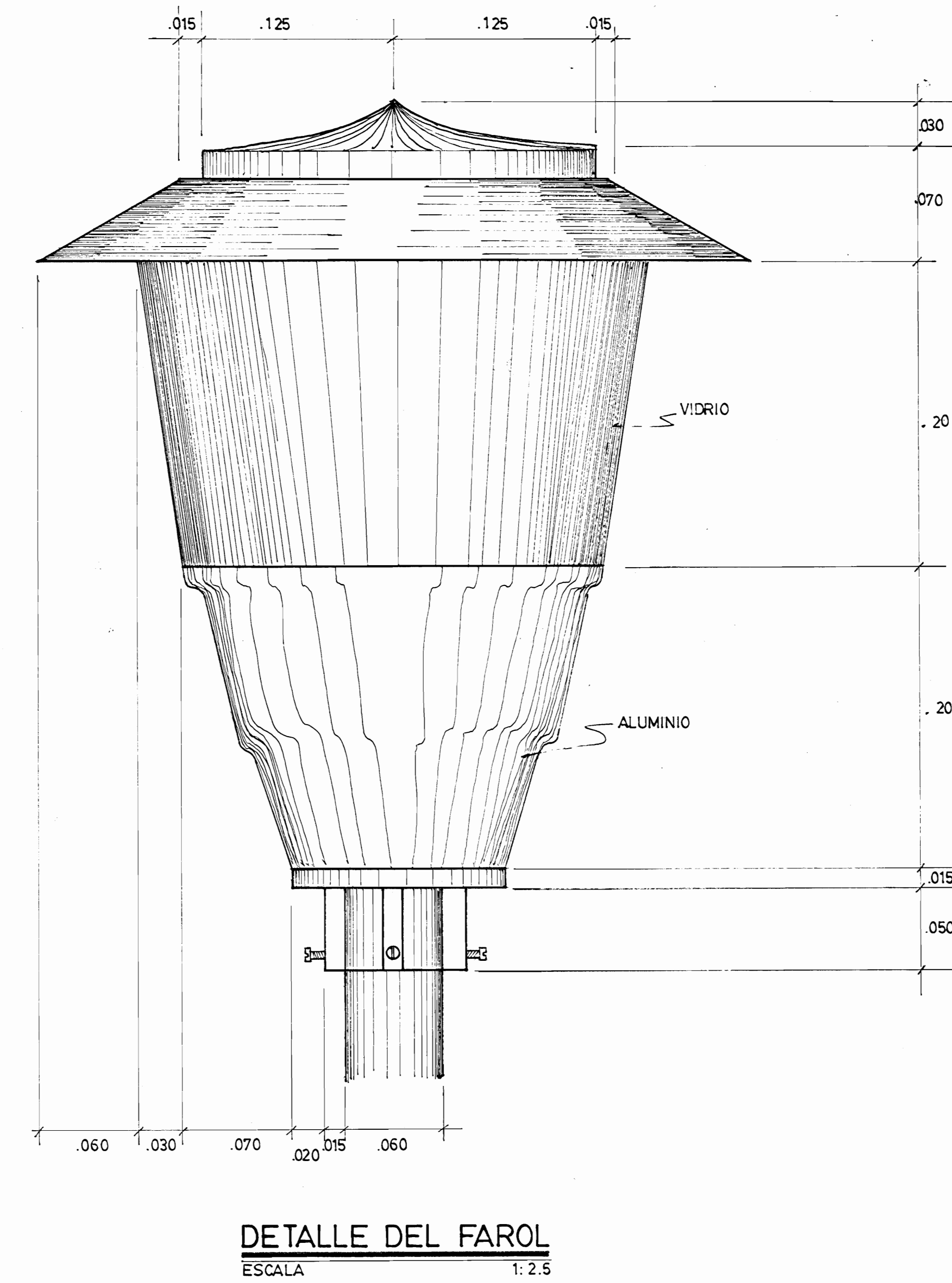
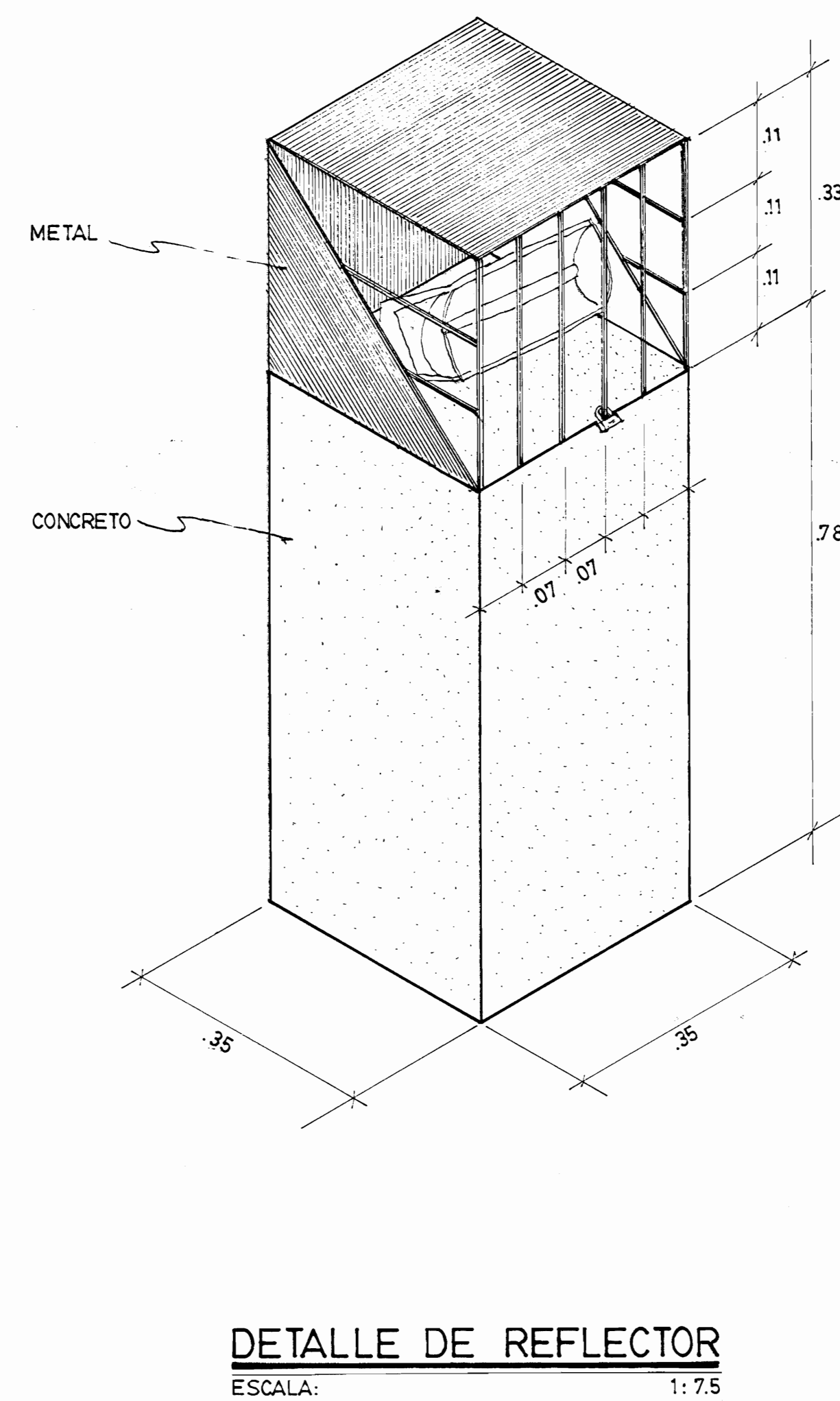
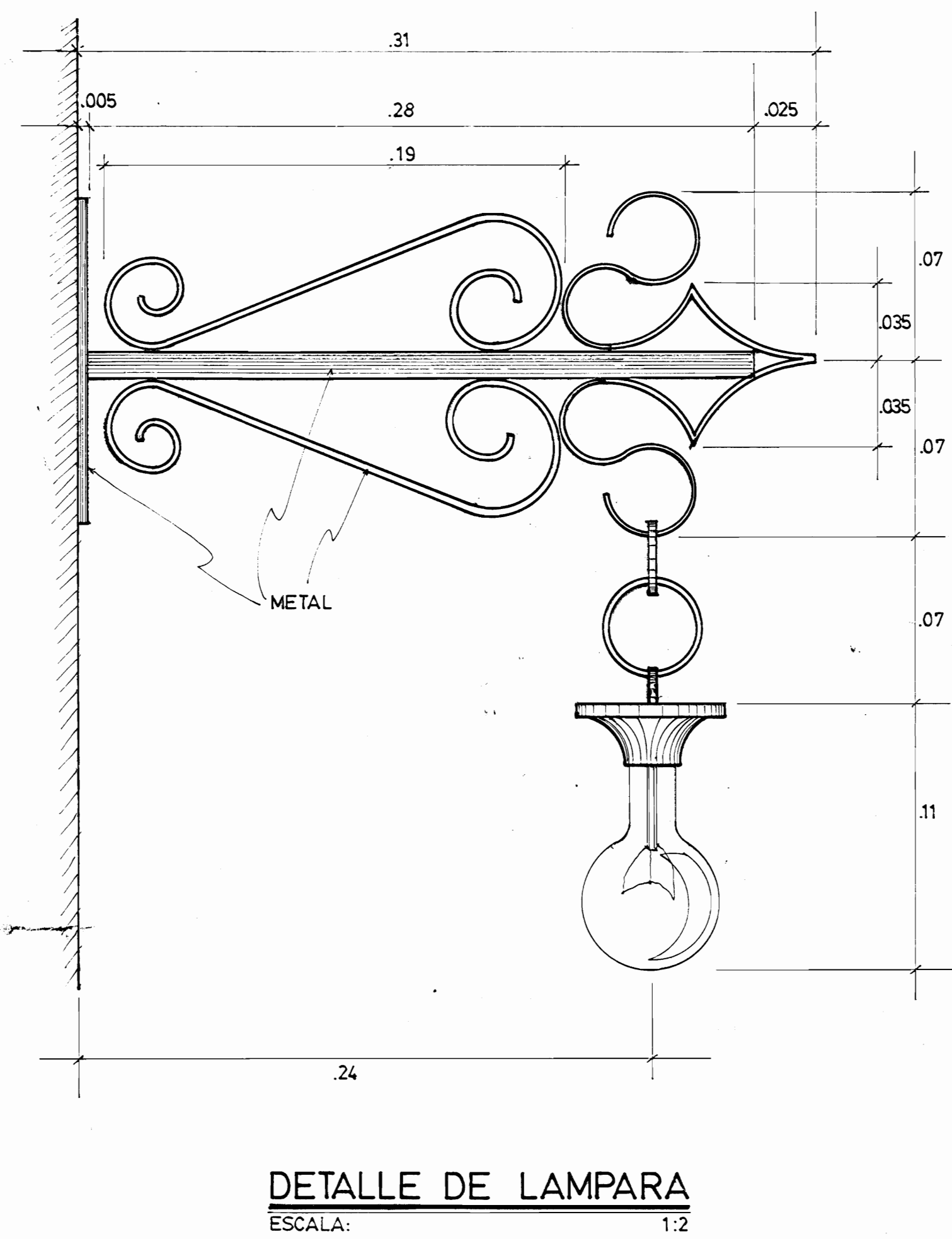
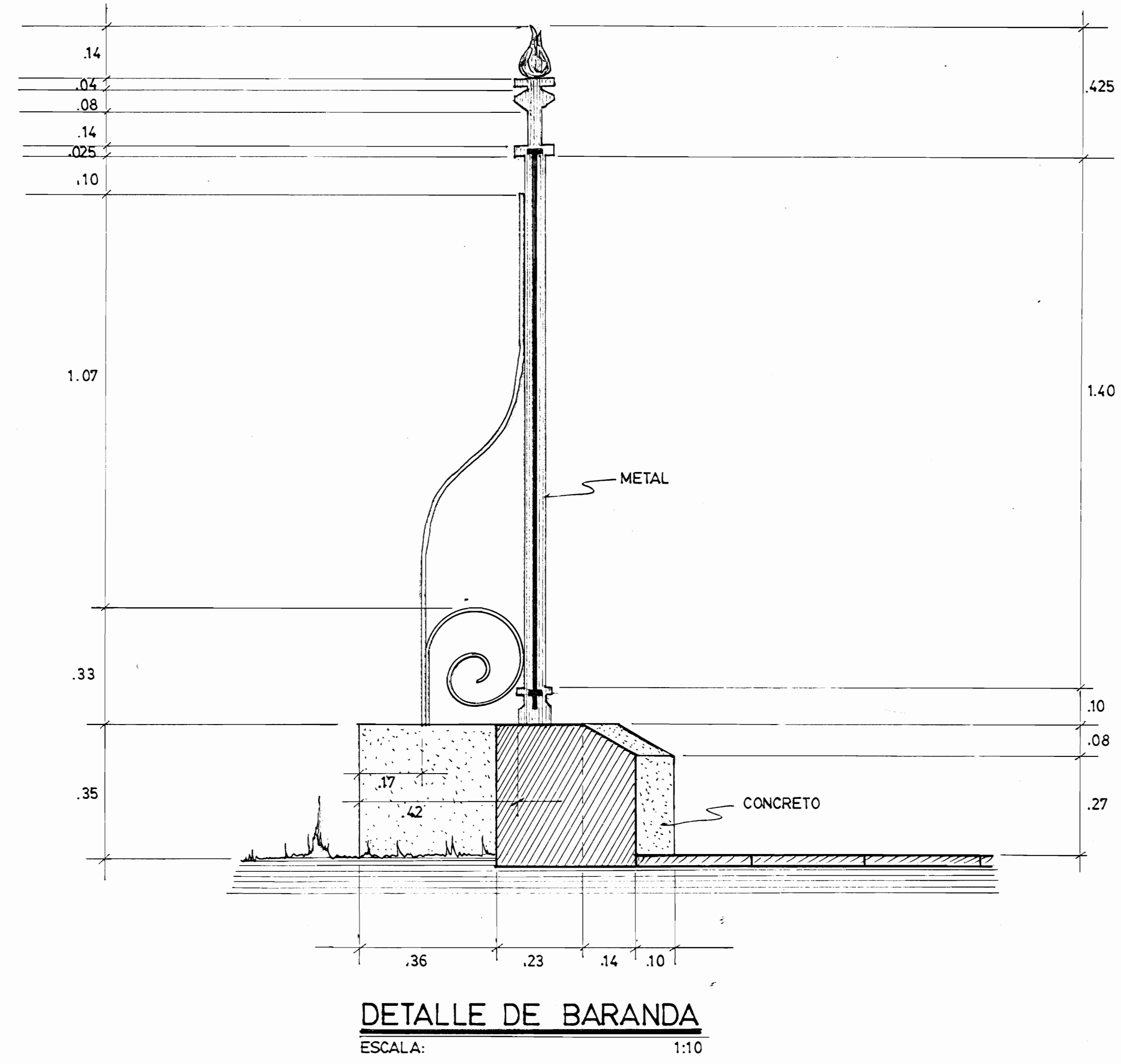
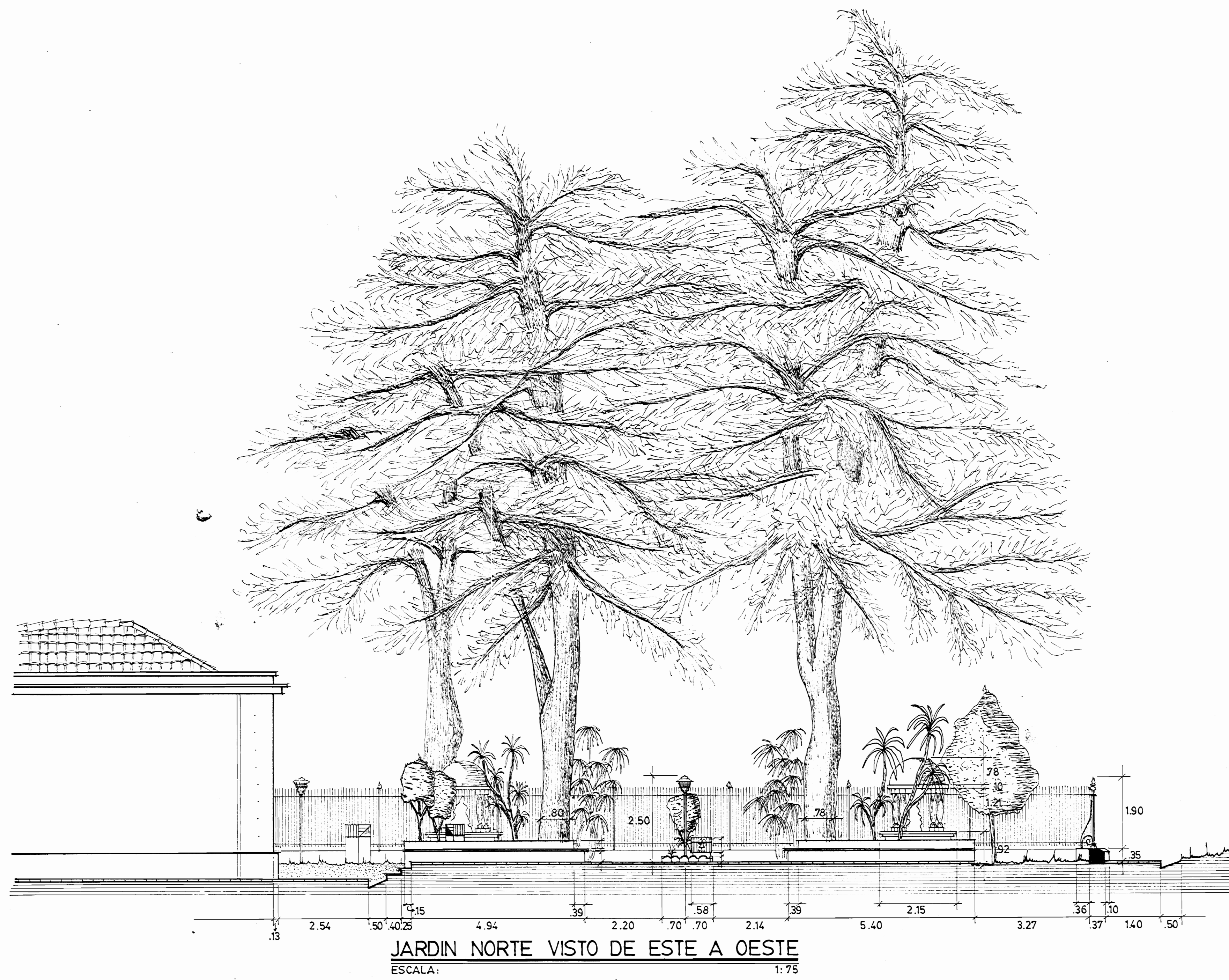

UNIVERSIDAD DE COSTA RICA ESCUELA DE ARQUITECTURA		
LEVANTAMIENTO IGLESIA SAN JOAQUIN DE FLORES		
provincia : Heredia	canton : Central	distrito : San Joaquín
<b>DA</b>		
AUTOR: Marco V. Salano S.		
INTEGRANTES: Reddy Bolaños M. Vera Fernández M. Marco V. Salano S.		
CONTENIDO: - JARDIN NORTE VISTO DE ESTE A OESTE - DETALLES.		
ESCALA INDICADA	FECHA 3 / 6 / 88	# LAMINA

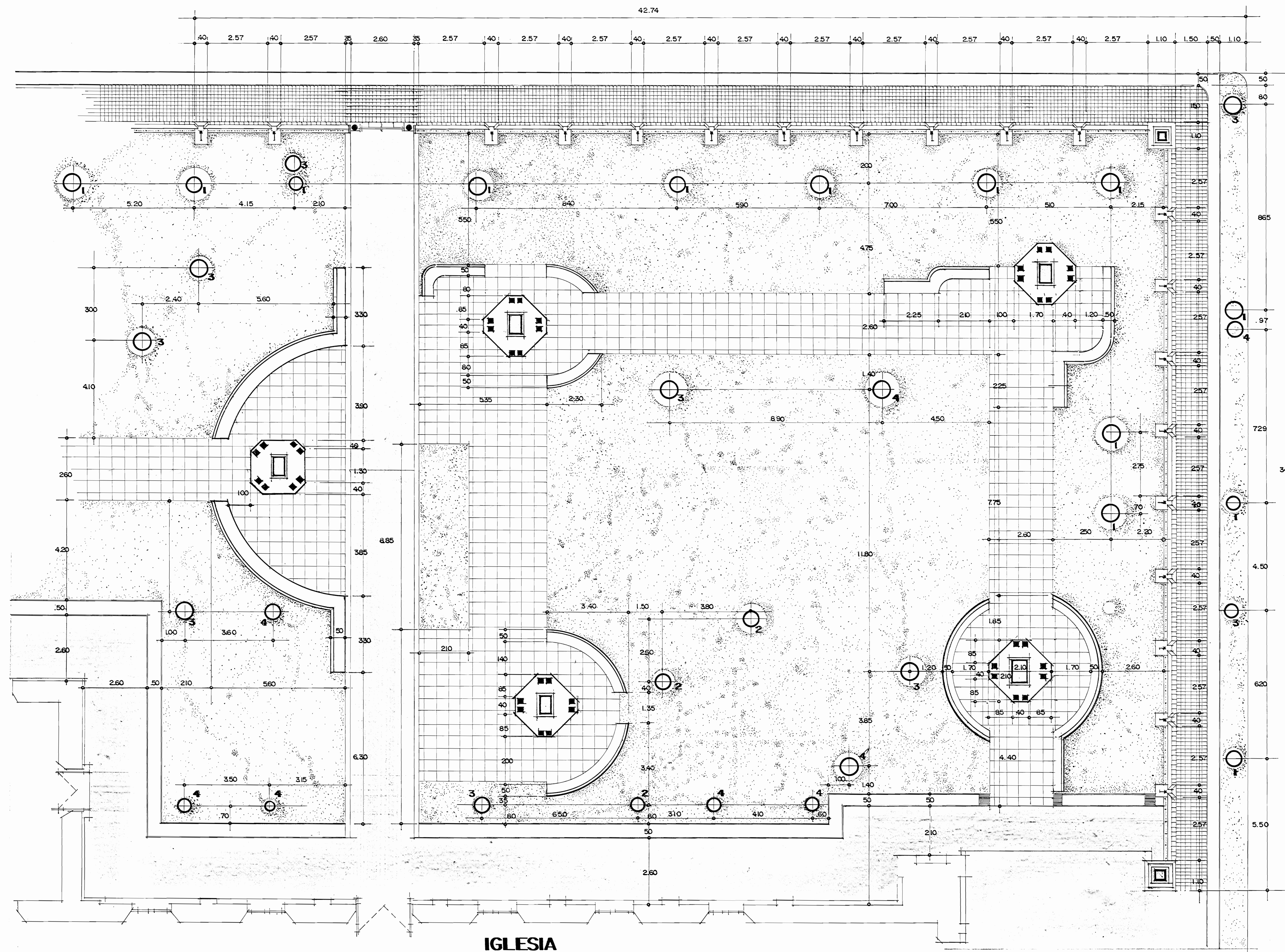





PLANTA SECTOR SUROESTE

ESC 1:75

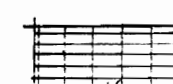
**SIMBOLOGIA**

**TEXTURAS DE PISO**

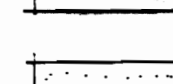
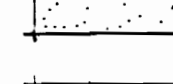
-  ACERA (VER DETALLE LAMINA Nº6)
-  MOSAICO IGLESIA
-  MOSAICO
-  PIEDRA
-  ZONA VERDE
-  ADOQUIN

**TIPO DE VEGETACION**

- 1** PALMERA
- 2** CIPRES
- 3** OTROS ARBOLES
- 4** ARBUSTOS PEQUEÑOS
- 5**

UNIVERSIDAD DE COSTA RICA  
ESCUELA DE ARQUITECTURA

**LEVANTAMIENTO  
IGLESIA**

PROVINCIA HEREDIA	CANTON FLORES	DISTRITO SAN JOAQUIN
----------------------	------------------	-------------------------



INTERANTES

ALTAMIRANO SONIA  
AZOFEIFA CARLOS  
BLANCO ADOLFO  
VARGAS JOSE ANGEL

CONTENIDO

PLANTA SECTOR SUROESTE

ESCALA	FECHA	LAMINA
INDICADA	3-6-88	2/6

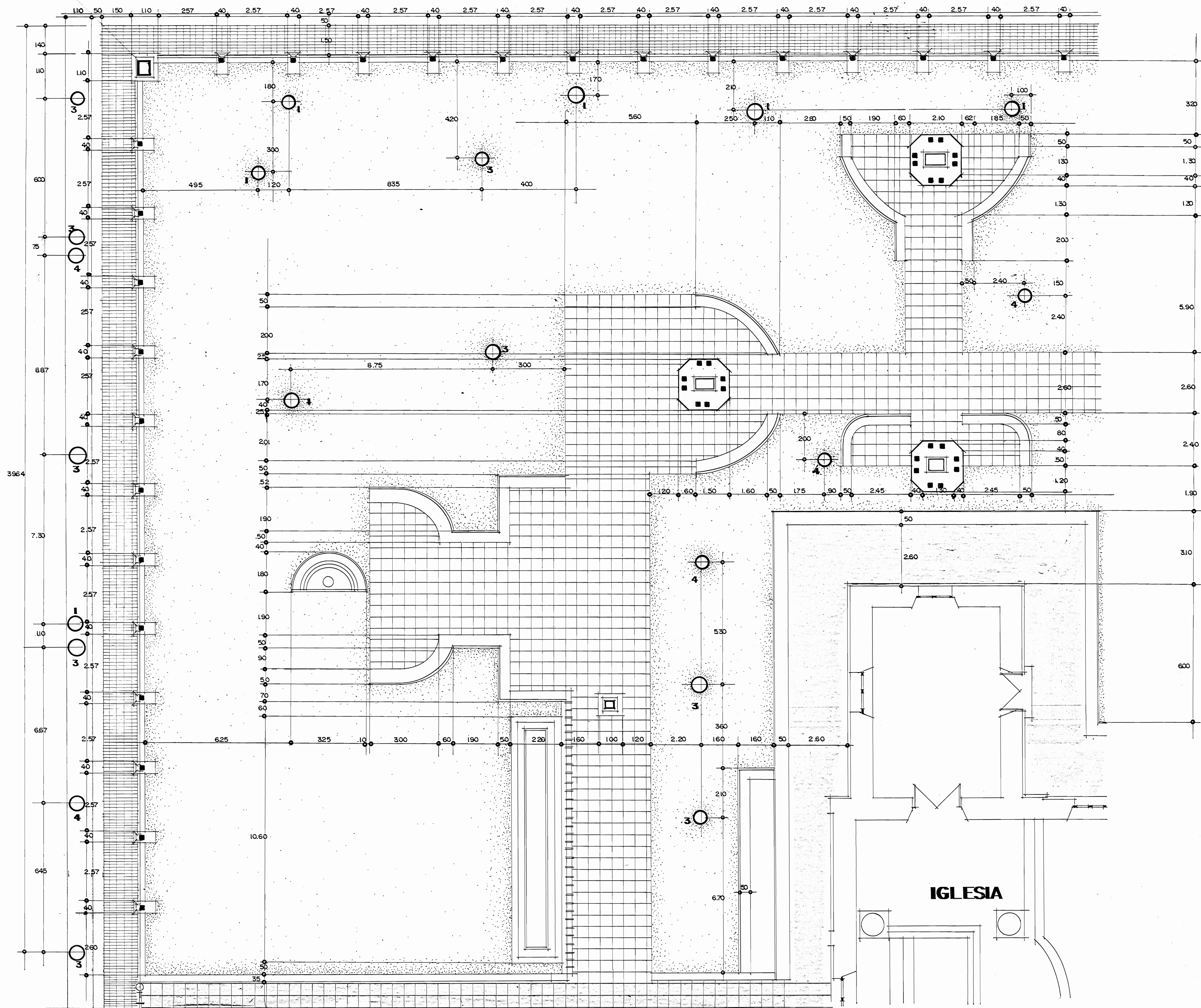

PLANTA SECTOR SURESTE

ESC 1:75

UNIVERSIDAD DE COSTA RICA  
 ESCUELA DE ARQUITECTURA

LEVANTAMIENTO  
 IGLESIA

PROVINCIA HEREDIA	CANTON FLORES	DISTRITO SAN JOAQUIN
----------------------	------------------	-------------------------



INTEGRANTES

ALTAMIRANO SOMIA  
 AZOFEIFA CARLOS  
 BLANCO ADOLFO  
 VARGAS JOSE ANGEL

CONTENIDO

PLANTA SECTOR SURESTE

ESCALA	FECHA	LAMINA
INDICADA	3-6-88	3/6

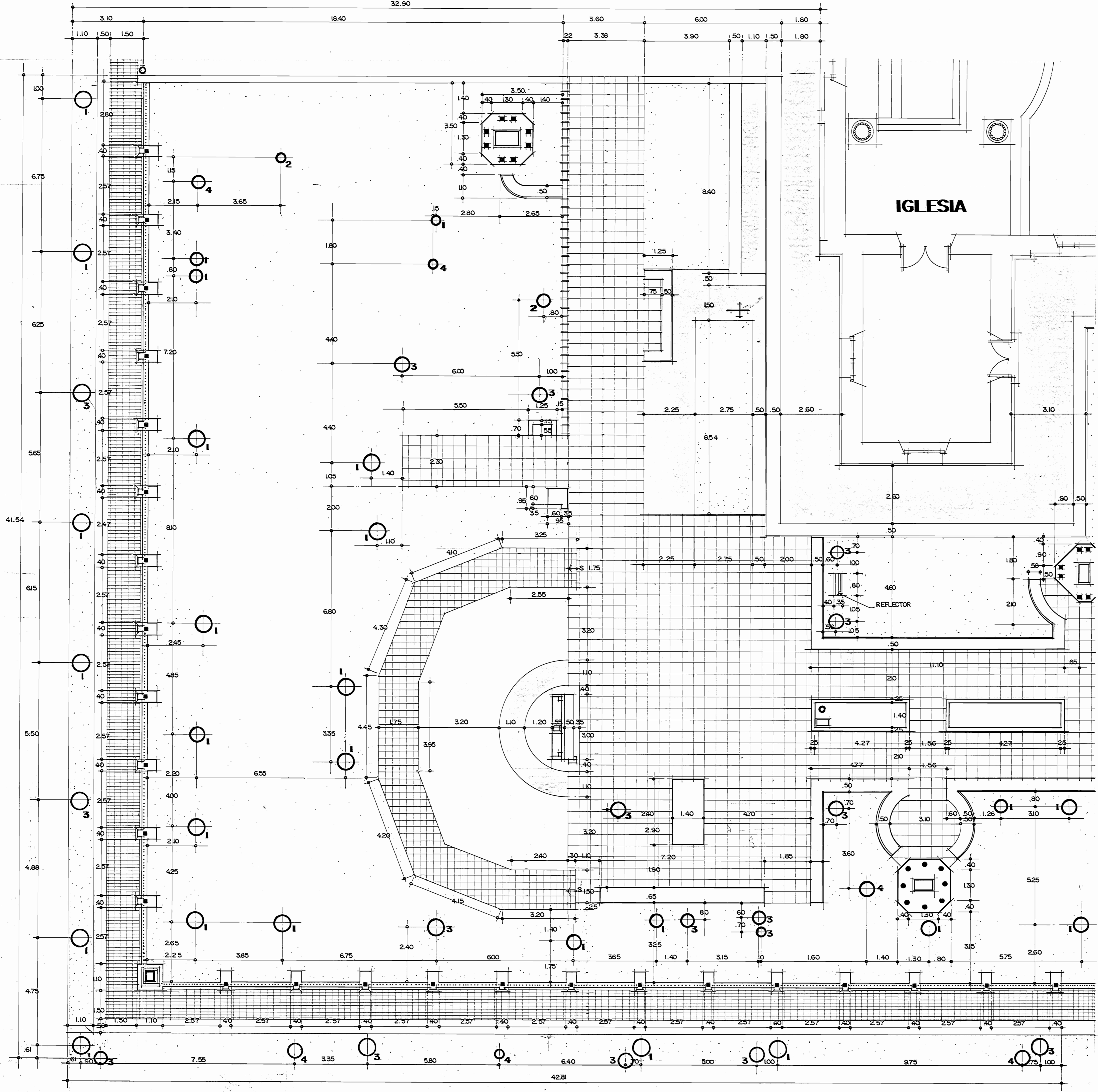

PLANTA SECTOR NORESTE

ESC 1:75

UNIVERSIDAD DE COSTA RICA  
ESCUELA DE ARQUITECTURA

**LEVANTAMIENTO  
IGLESIA**

PROVINCIA HEREDIA	CANTON FLORES	DISTRITO SAN JOAQUIN
----------------------	------------------	-------------------------



INTEGRANTES:

- ALTAMIRANO SONIA
- AZOFEIFA CARLOS
- BLANCO ADOLFO
- VARGAS JOSE ANGEL

CONTENIDO:

PLANTA SECTOR NOR-ESTE

ESCALA	FECHA	LAMINA
INDICADA	3-6-88	4/6

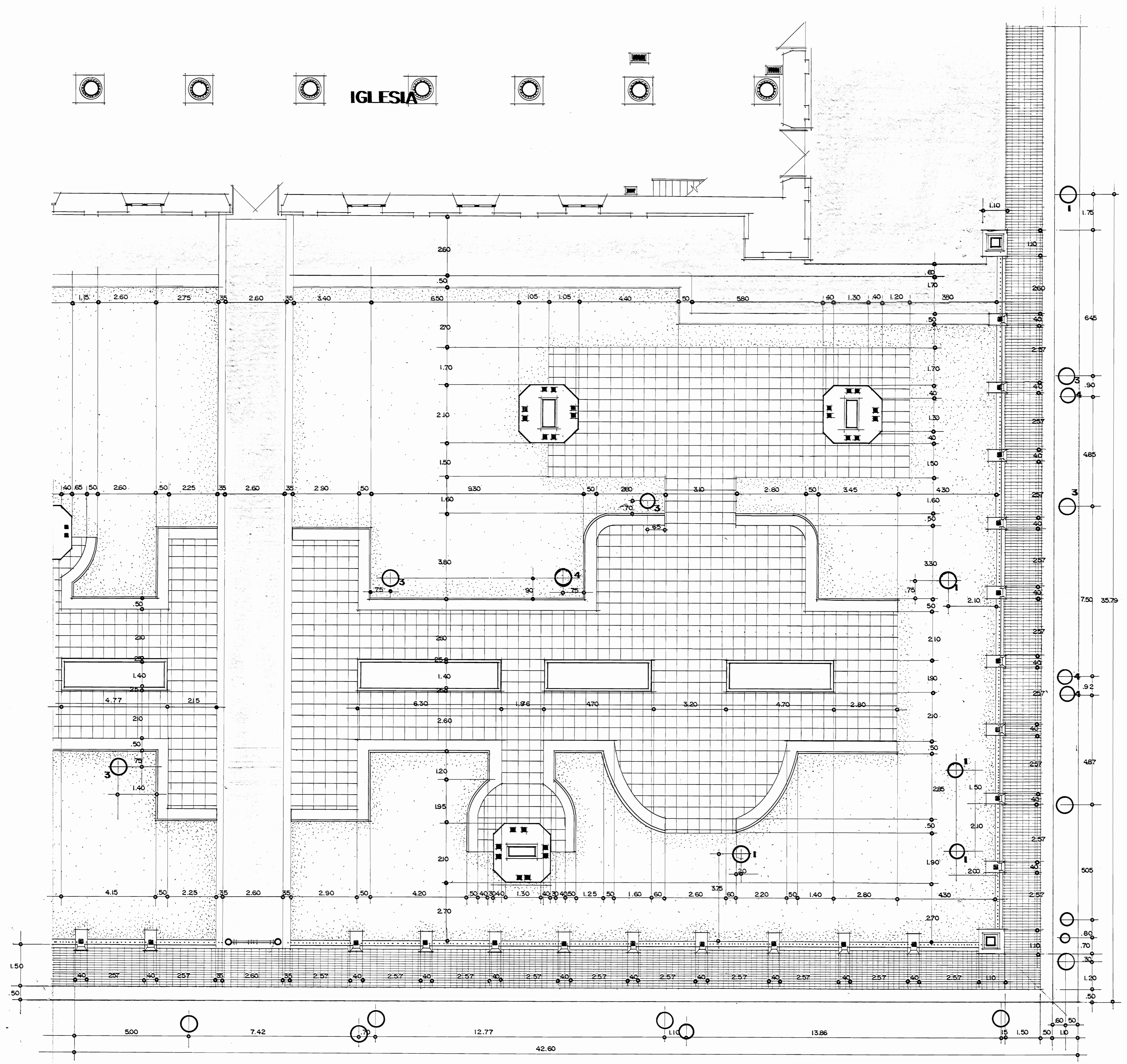

PLANTA SECTOR NOROESTE

ESC 1:75

UNIVERSIDAD DE COSTA RICA  
 ESCUELA DE ARQUITECTURA

**LEVANTAMIENTO IGLESIA**

PROVINCIA HEREDIA	CANTON FLORES	DISTRITO SAN JOAQUIN
----------------------	------------------	-------------------------

**IXI**

INTEGRANTES

ALTAMIRANO SONIA  
 AZOFEIFA CARLOS  
 BLANCO ADOLFO  
 VARGAS JOSE ANGEL

CONTENIDO

PLANTA SECTOR NOROESTE

ESCALA	FECHA	LAMINA
INDICADA	3-6-88	5/6



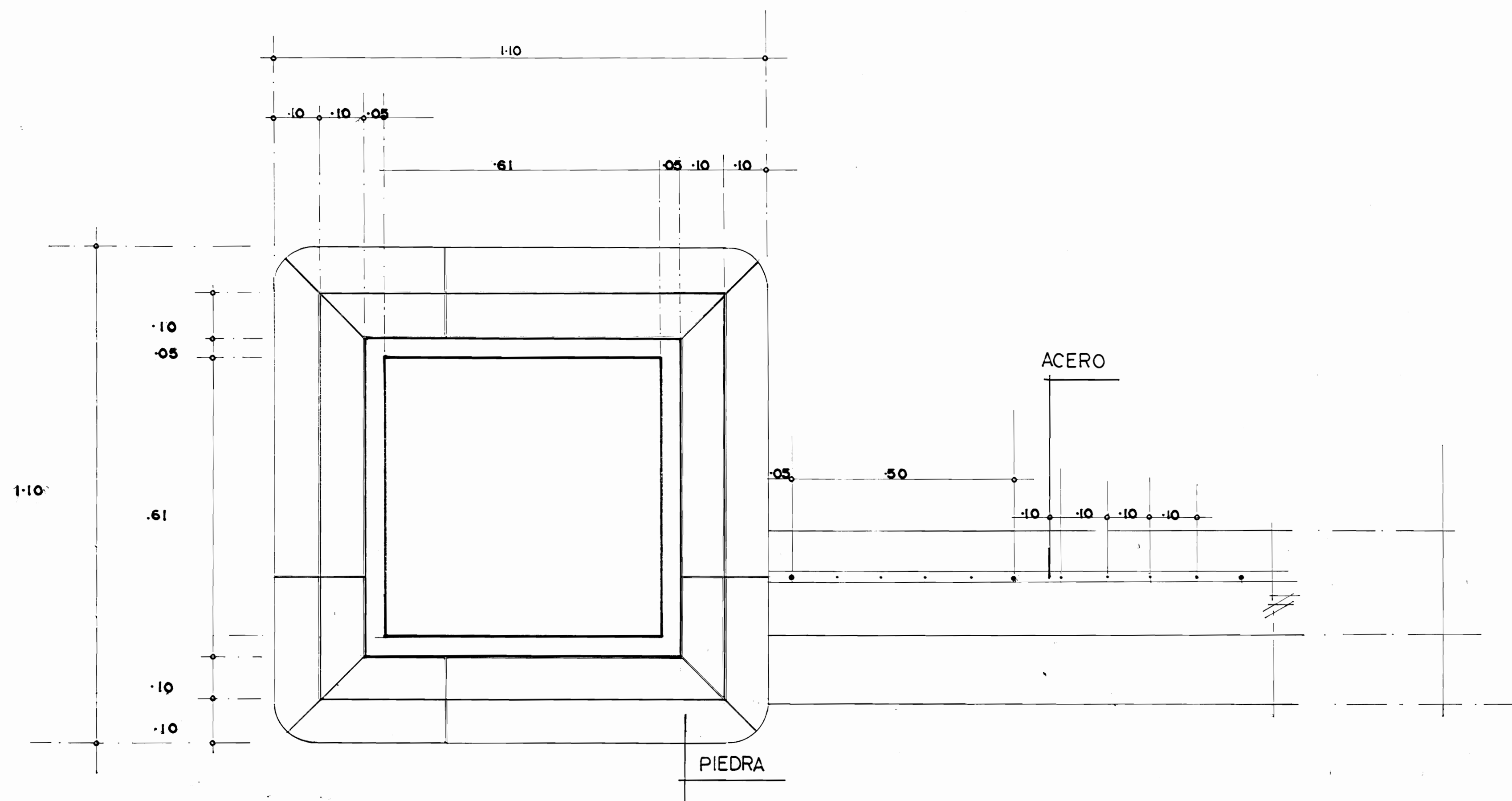

DETALLE DE COLUMNA EN EL MURO ①

DETALLE DE COLUMNA DE PORTON

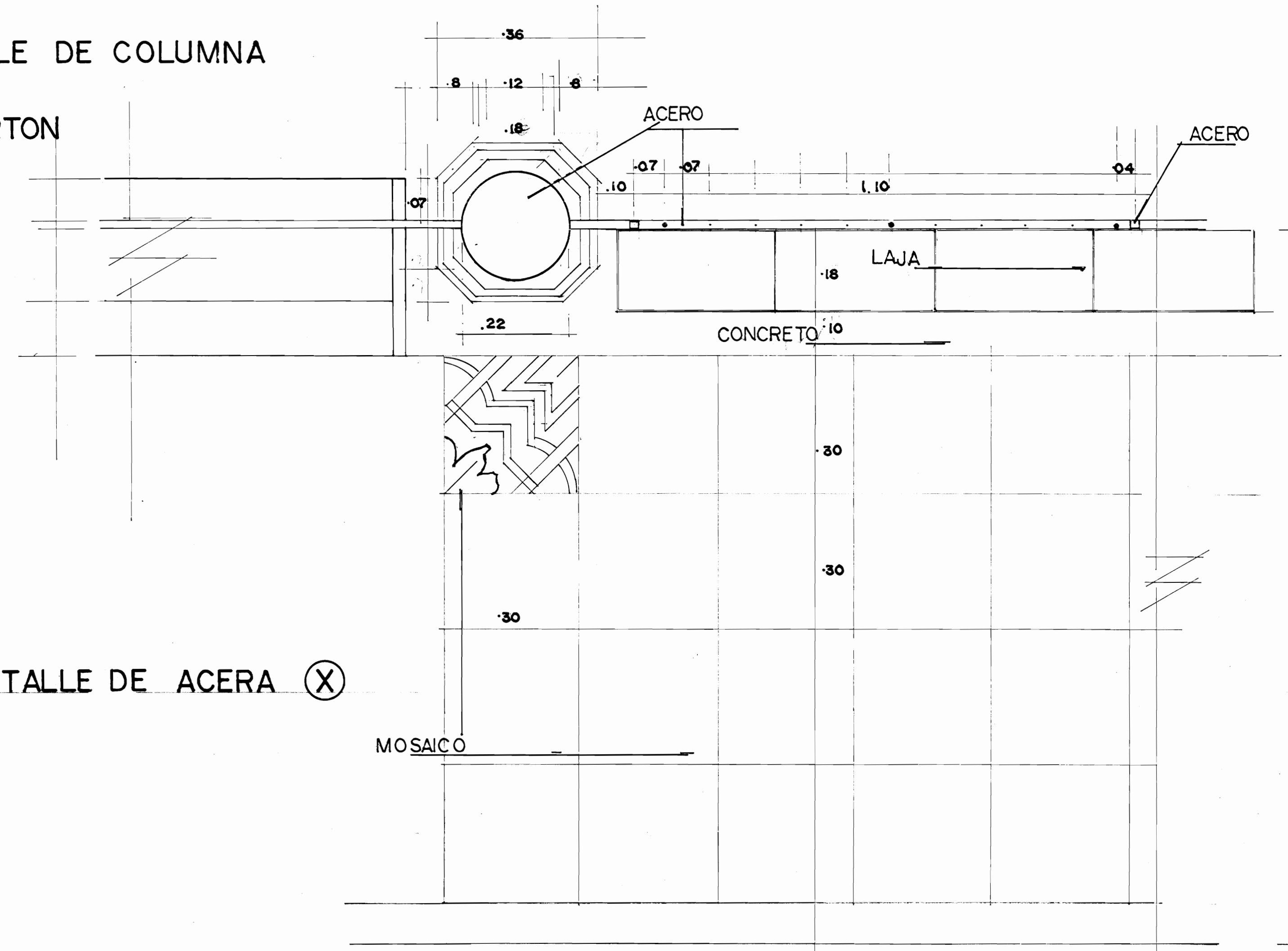

DETALLE DE ACERA (X)

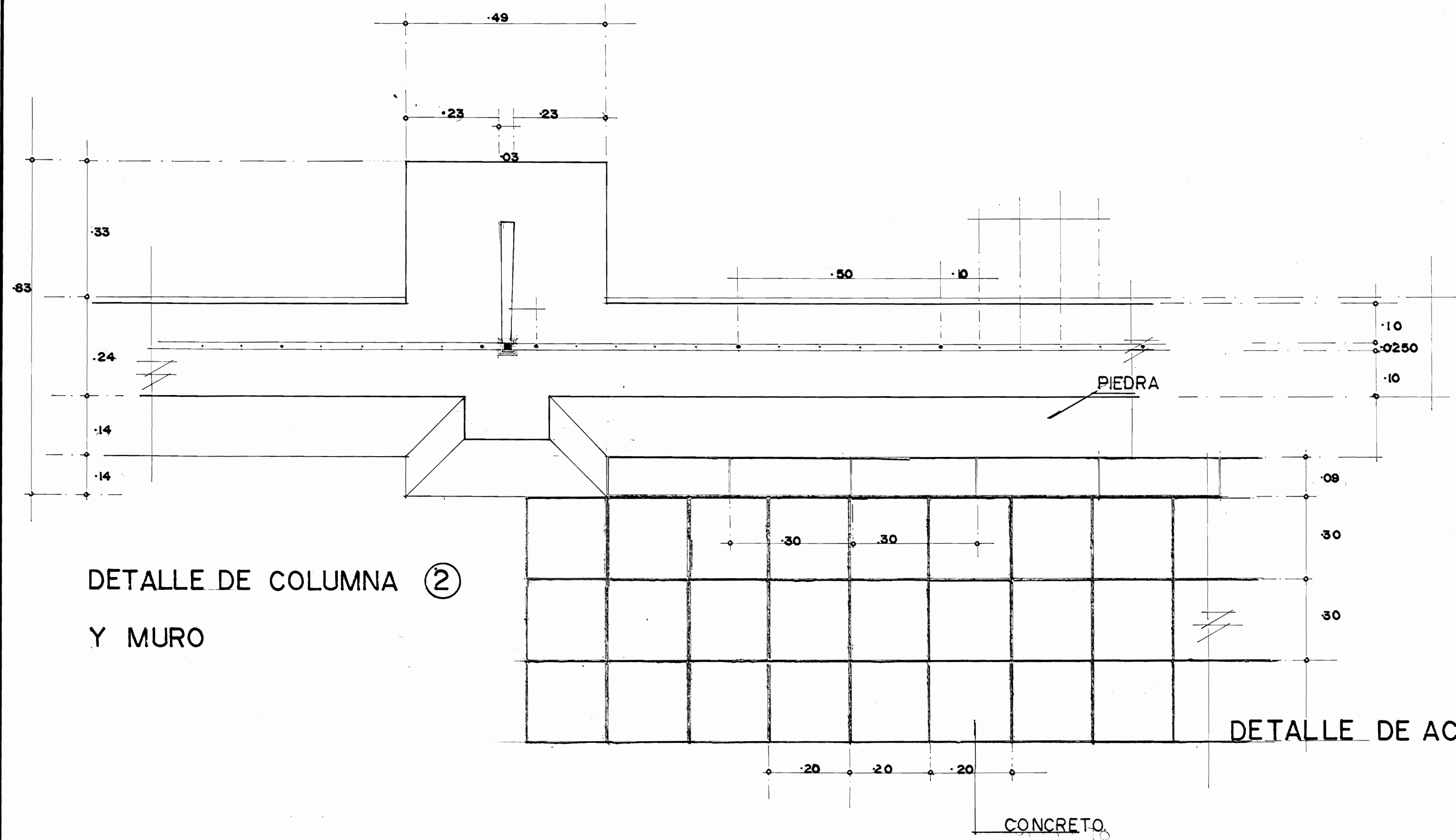

DETALLE DE COLUMNA Y MURO ②

DETALLE DE ACERA (Y)

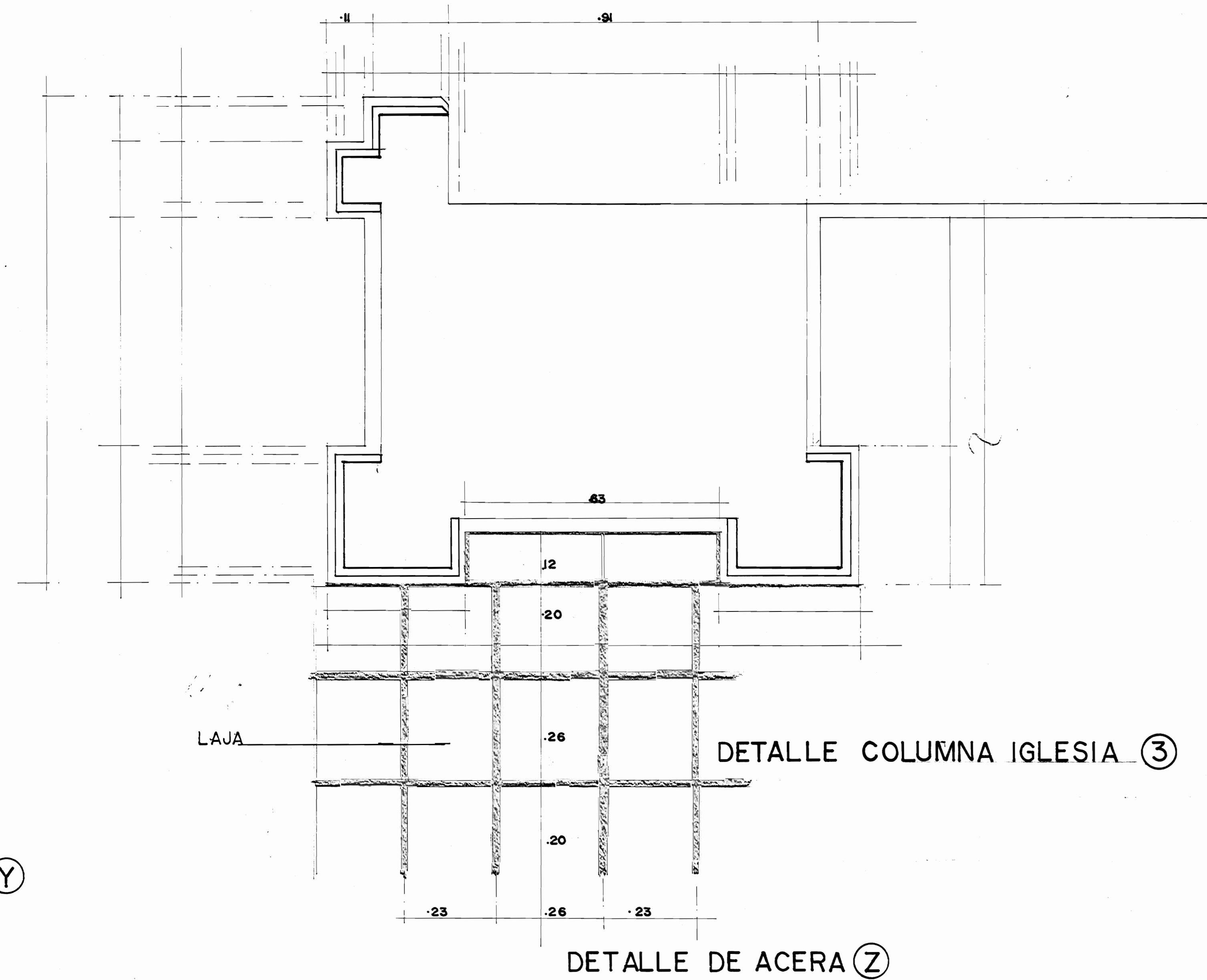

DETALLE COLUMNA IGLESIA ③

DETALLE DE ACERA (Z)

UNIVERSIDAD DE COSTA RICA  
ESCUELA DE ARQUITECTURA

LEVANTAMIENTO  
IGLESIA

PROVINCIA HEREDIA CANTON FLORES DISTRITO SAN JOAQUIN

ILX7

INTEGRANTES:

ALTAMIRANO SOMIA  
AZOFEIFA CARLOS  
BLANCO ADOLFO  
VARGAS JOSE ANGEL

CONTENIDO:

DETALLES

ESCALA	FECHA	LAMINA
INDICADA	3-6-88	6/6