



PROPUESTA ARQUITECTONICA - VISTA EXTERNA
NIVELES 1 Y 2



PROPUESTA ARQUITECTONICA - PASILLO CENTRAL
NIVEL 1

PROYECTO:

RESTAURACION DE ANTIGUA FERRETERIA MACAYA

DISEÑO: ARQUITECTO ELIAS ROBLES FERNANDEZ

AGOSTO 2011



Tekna Constructores CRS S.A.
Of. 2281-3637 Fax. 2281-3738
P.O. Box 252-2050

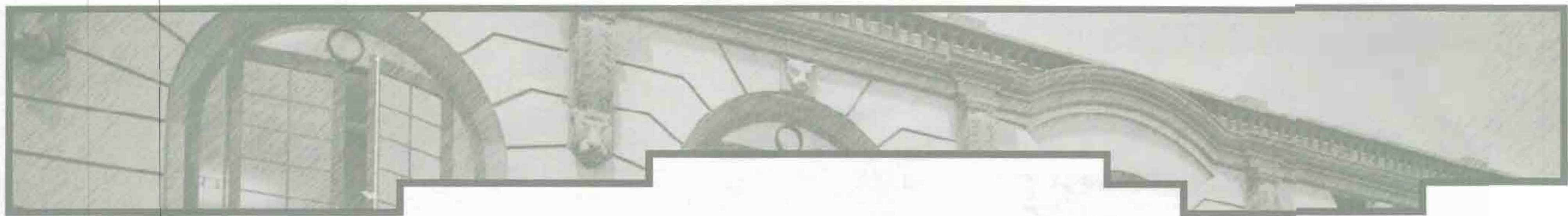

PROPUESTA ARQUITECTONICA - ESCALERA PRINCIPAL
NIVELES 1 Y 2



PROPUESTA ARQUITECTONICA - CAFETERIA
NIVEL 2

PROYECTO:

RESTAURACION DE ANTIGUA FERRETERIA MACAYA

DISEÑO: ARQUITECTO ELIAS ROBLES FERNANDEZ

AGOSTO 2011



Tekna Constructores QRE S. de RL
Of. 2211 J63, 7 Fax. 2281-3738
P.O. Box. 212-20570

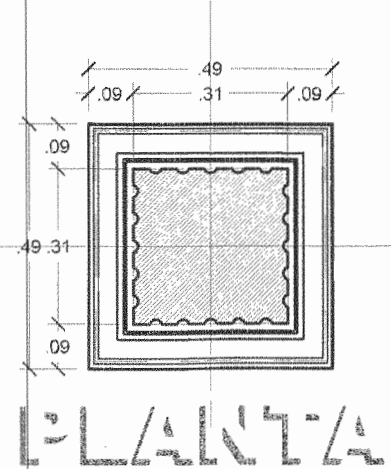

PLANTA

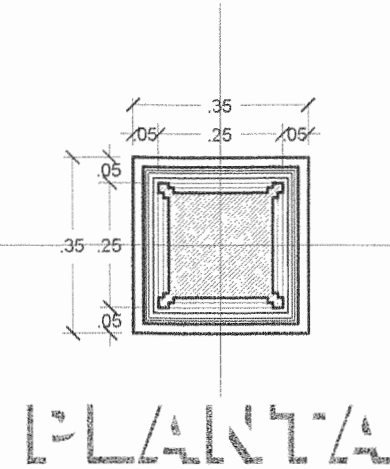

PLANTA

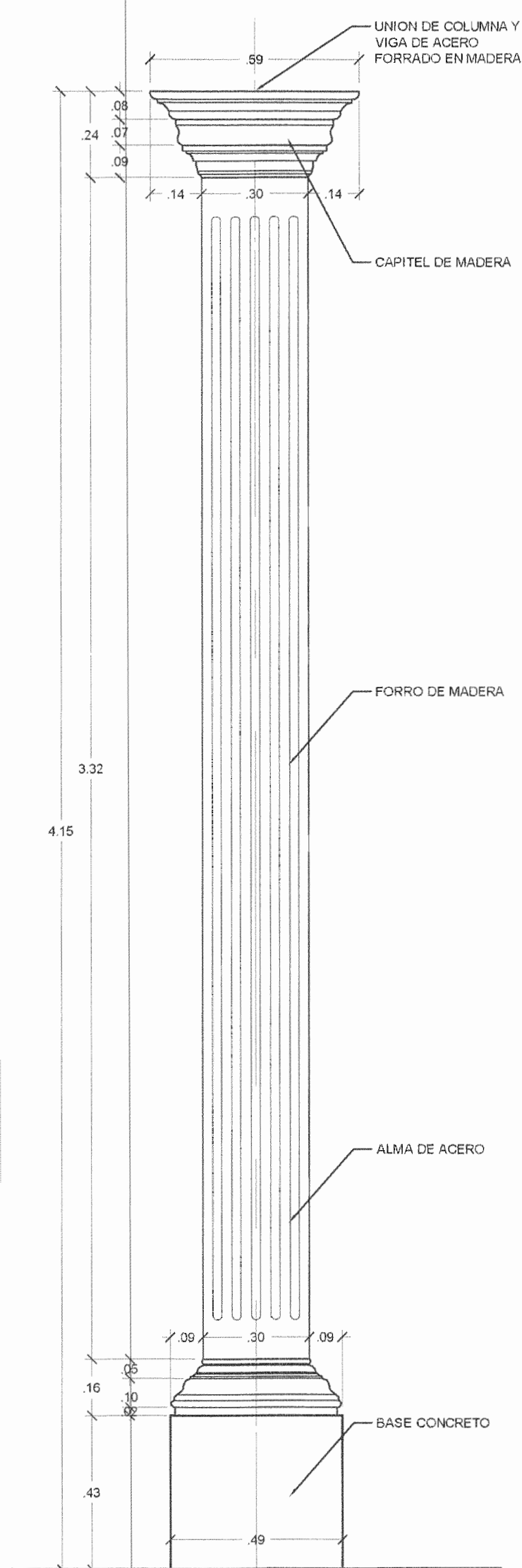

ELEVACION

DETALLE DE COLUMNA 1
ESCALA 1:15

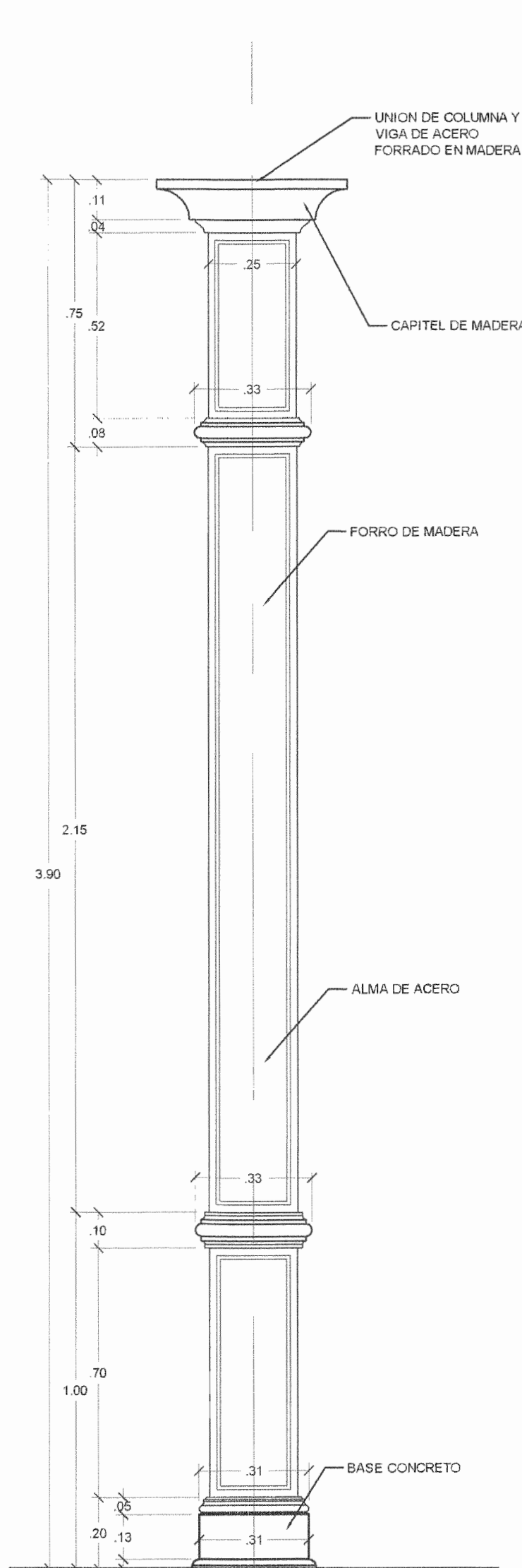

ELEVACION

DETALLE DE COLUMNA 2
ESCALA 1:15

DET 2, PERFIL DE CAPITEL
ESCALA 1:15

DET 1, PERFIL DE PEDESTAL
ESCALA 1:15

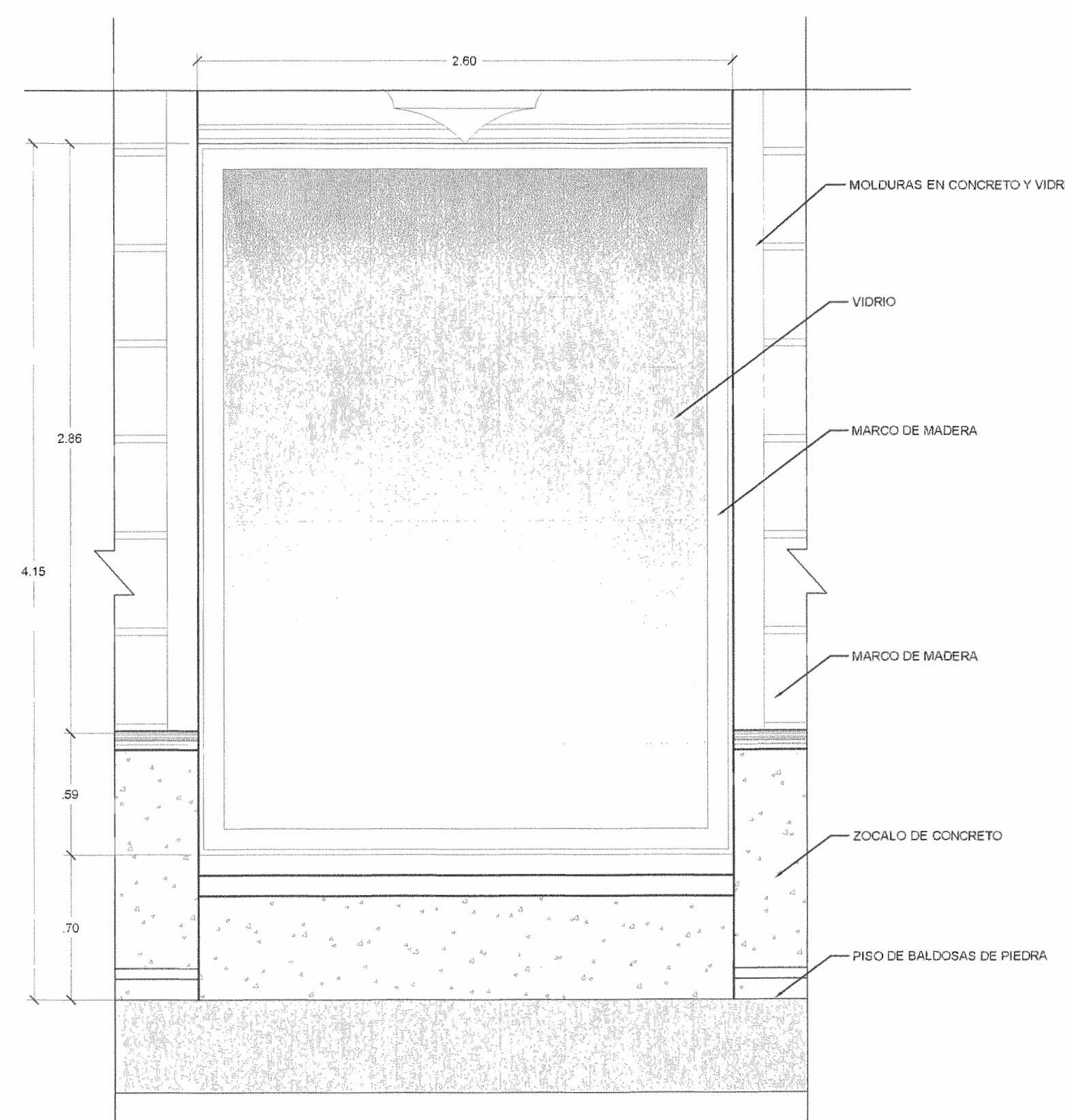

DETALLE DE VENTANA TIPICA
ESCALA 1:25

DET 4, PERFIL DE CAPITEL
ESCALA 1:15

DET 3, PERFIL DE PEDESTAL
ESCALA 1:15

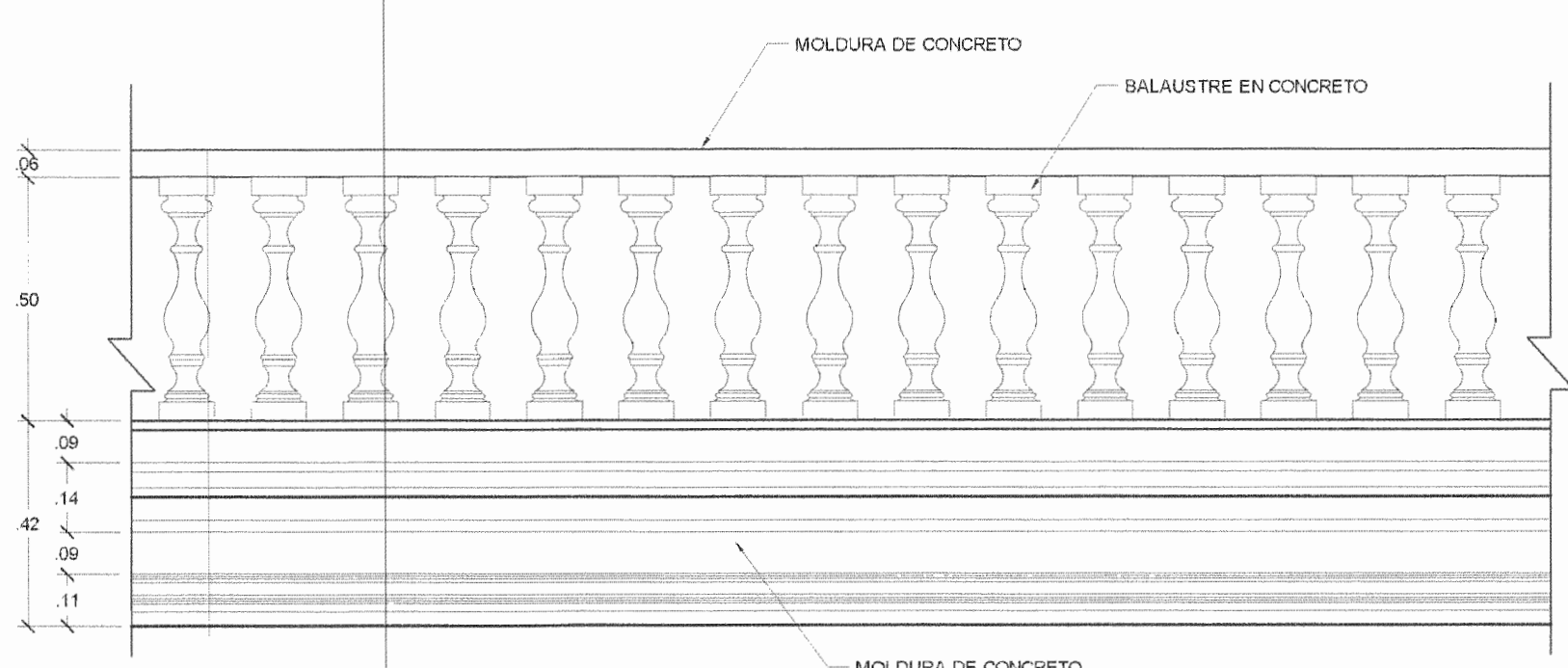

ELEVACION

DETALLE DE BALAUSTRADA SUPERIOR
ESCALA 1:15

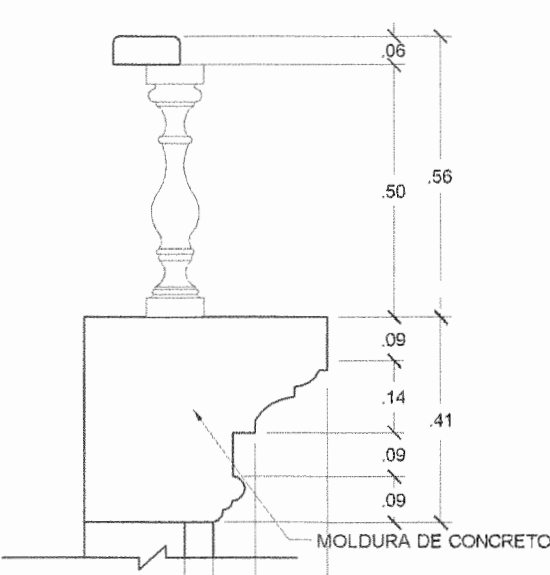

SECCION

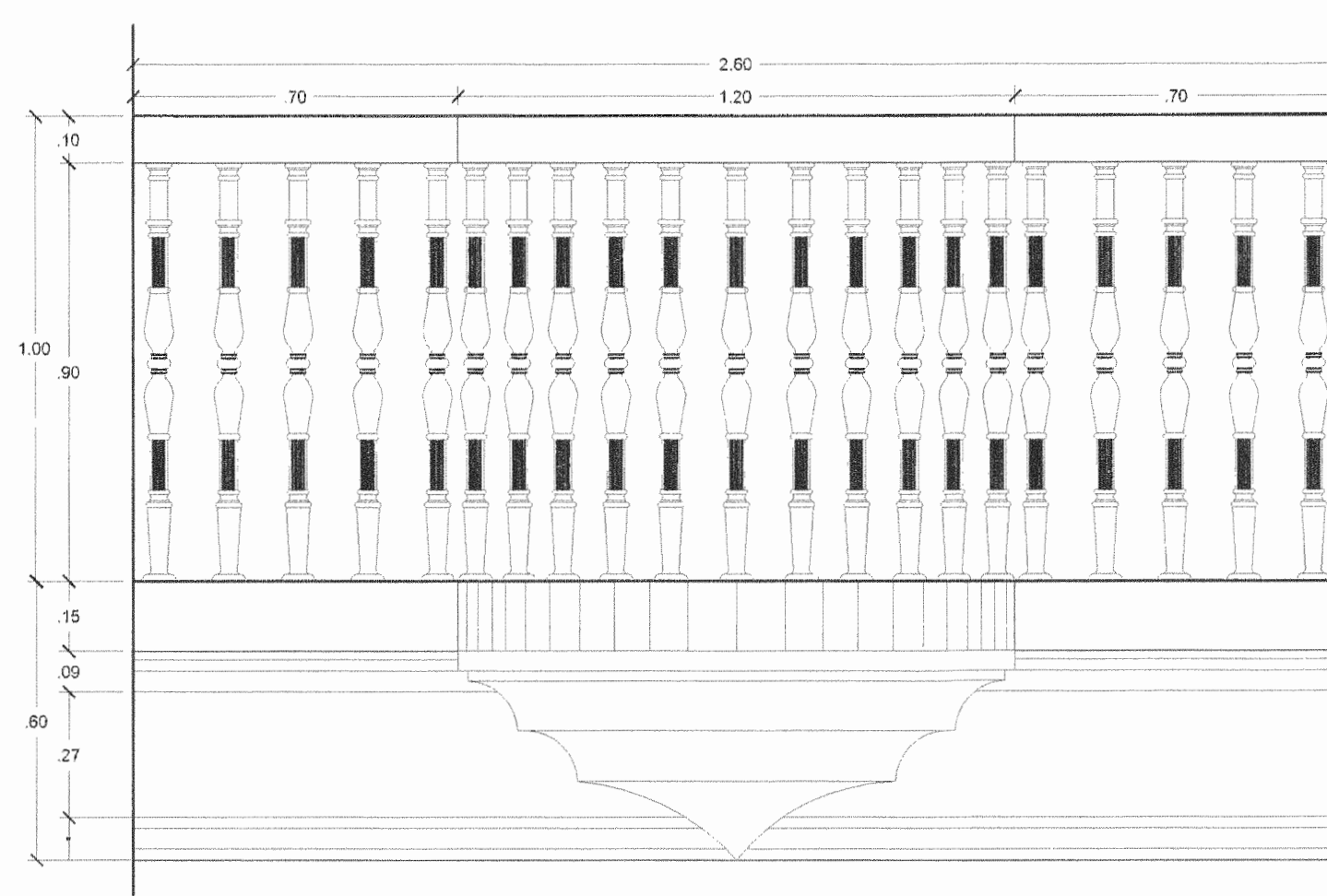

DETALLE DE BARANDA Y BALCON
ESCALA 1:15

PROYECTO:

RESTAURACION DE ANTIGUA FERRETERIA MACAYA

DISEÑO: ARQUITECTO ELIAS ROELIS FERNANDEZ

AGOSTO 2011



Tekna Constructores CRS S.A.
Of. 2281-3637 Fax. 2281-3738
PO. Box 252-2050

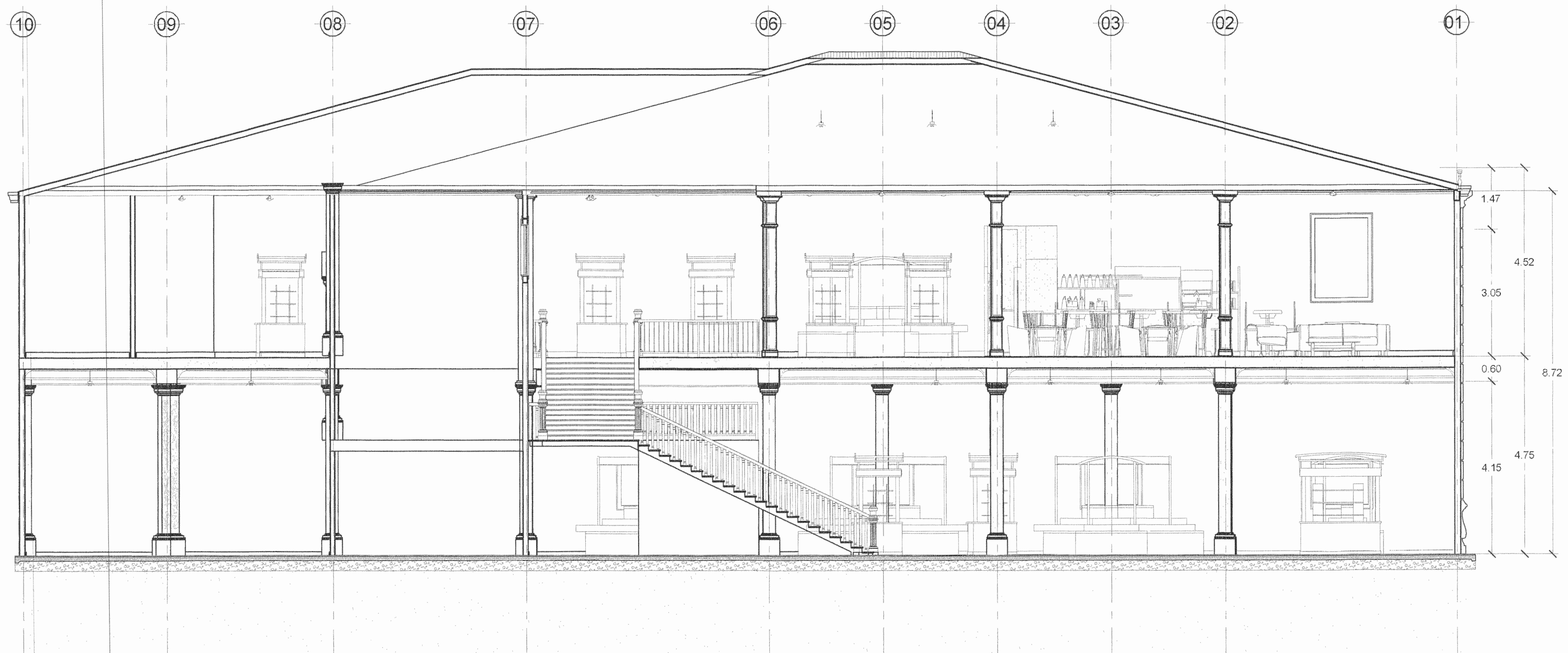
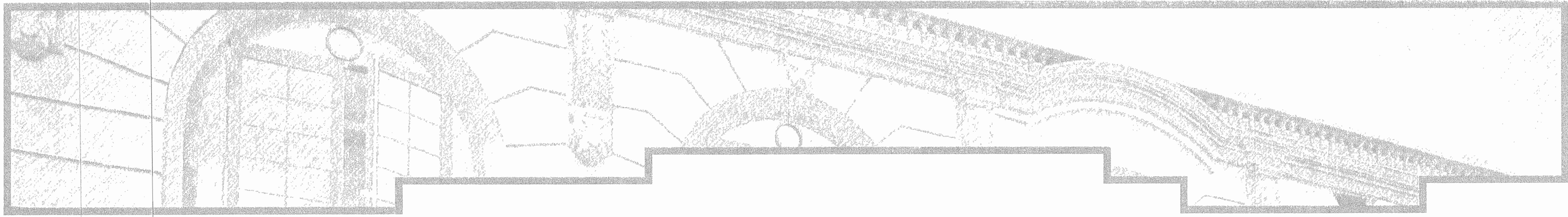

SECCION LONGITUDINAL
ESCALA 1:75

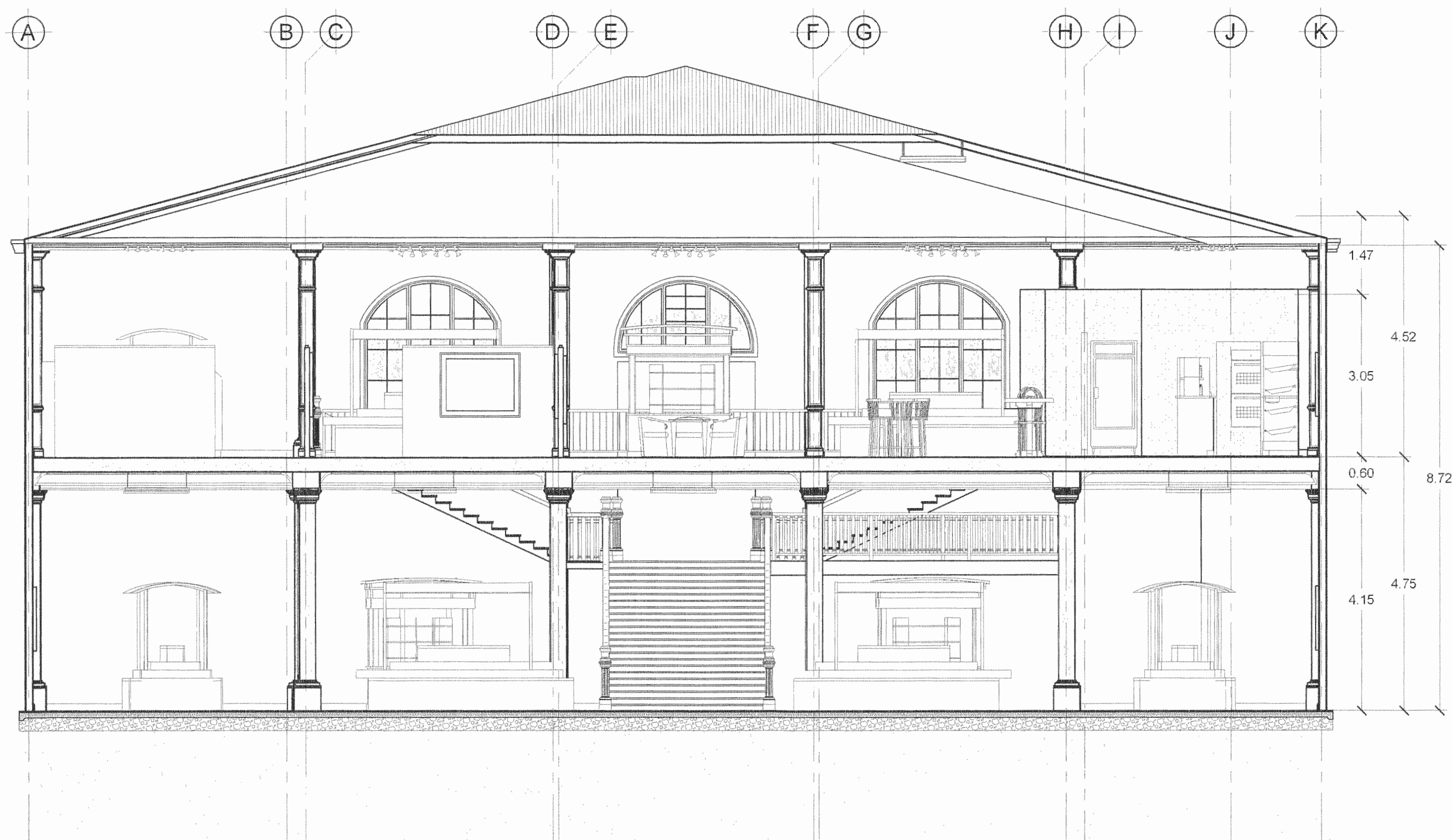

SECCION TRANSVERSAL
ESCALA 1:75

PROYECTO:

RESTAURACION DE ANTIGUA FERRETERIA MACAYA

DISEÑO: ARQUITECTO ELIAS ROBLES FERNANDEZ

AGOSTO 2011



Tekna Constructores CRS S.A.
Of. 2281-3637 Fax 2281-3738
PO. Box 252-2050



ELEVACION PRINCIPAL EXISTENTE
ESCALA 1:75



ELEVACION PRINCIPAL RESTAURADA
ESCALA 1:75

PROYECTO:

RESTAURACION DE ANTICUA FERRETERIA MACAYA

DISEÑO: ARQUITECTO ELIAS ROELIS FERNANDEZ

AGOSTO 2011



Tekna Constructores CRS S.A.
Of. 2281-3637 Fax: 2281-3738
PO. Box 252-2050

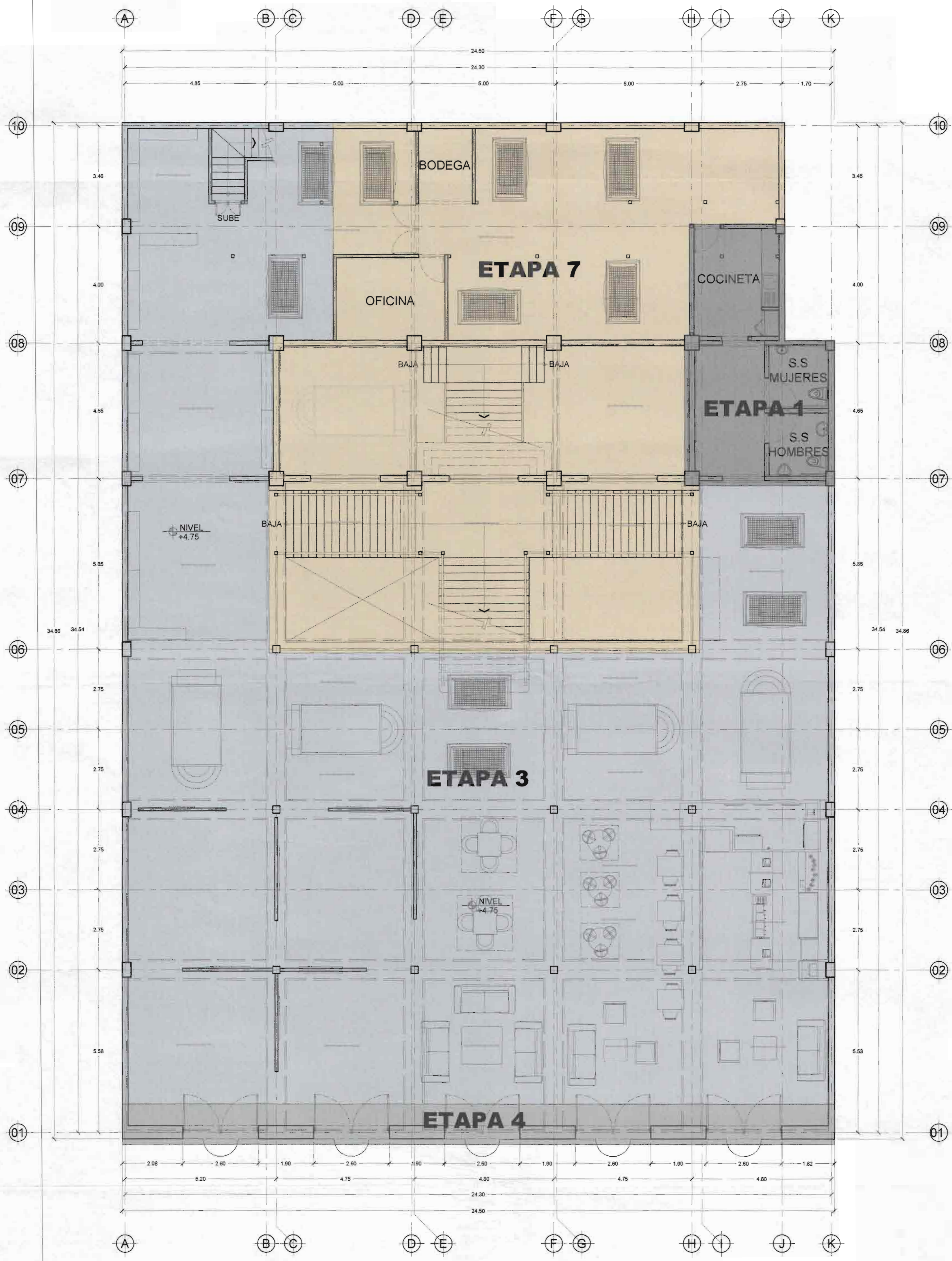

INDICACION DE ETAPAS PARA EL PROCESO DE RESTAURACION
NIVEL 2 +4.75mts
ESCALA 1:75

PROYECTO:

RESTAURACION DE ANTIGUA FERRETERIA MACAYA

DISEÑO: ARQUITECTO ELIAS ROBLES FERNANDEZ

AGOSTO 2011



Tekna Constructores CRS S.A.
Of. 2281-3637 Fax 2281-3738
P.O. Box 252-2050

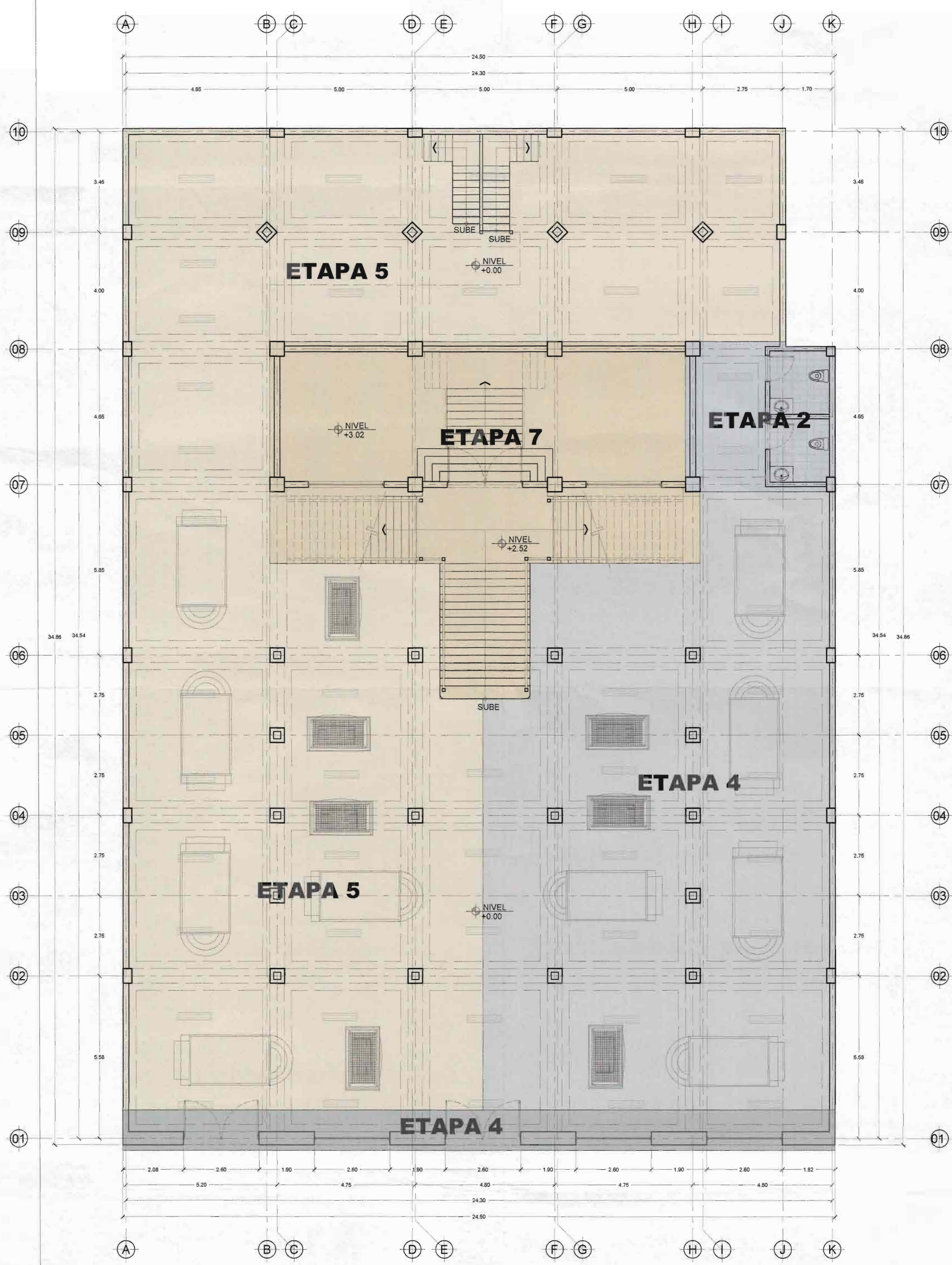
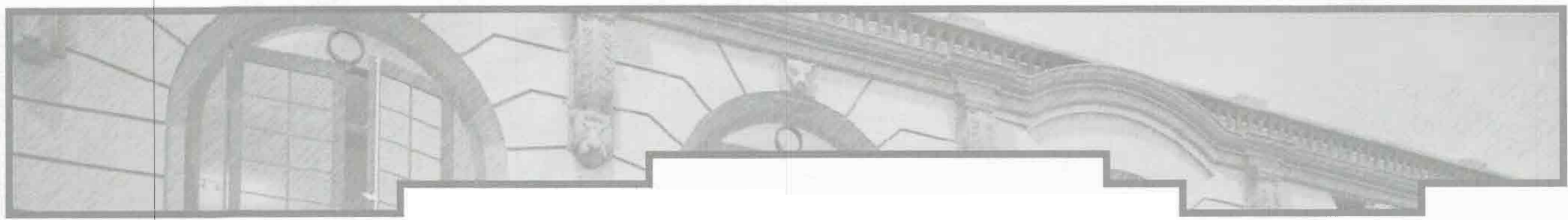

INDICACION DE ETAPAS PARA EL PROCESO DE RESTAURACION
 NIVEL 1 +0.00mts ESCALA 1:75

PROYECTO:

RESTAURACION DE ANTIGUA FERRETERIA MACAYA

DISEÑO: ARQUITECTO ELIAS ROBLES FERNANDEZ

AGOSTO 2011



Tekna Constructores CRS S.A.
 Of. 2281-3637 Fax. 2281-3738
 P.O. Box 252-2050

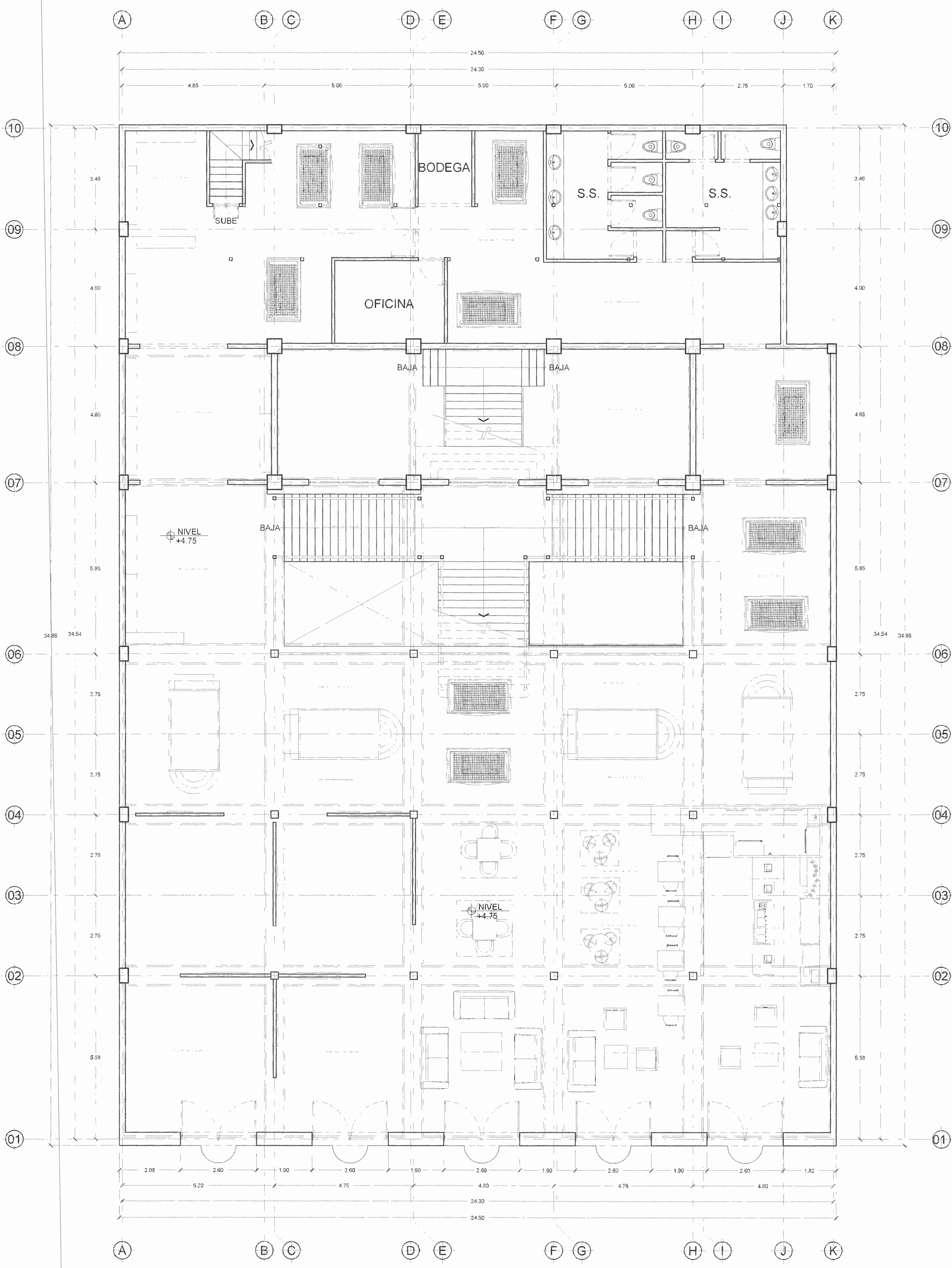
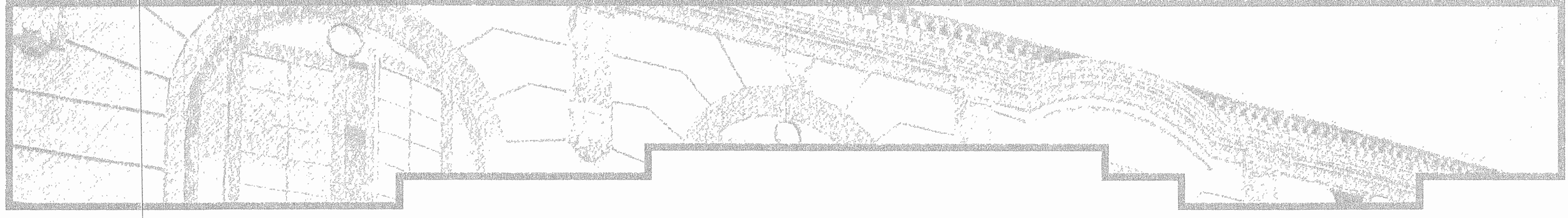

PLANTA DE DISTRIBUCION ARQUITECTONICA
 NIVEL 2 +4.75mts PROPUESTA ARQUITECTONICA ESCALA 1:75

PROYECTO:

RESTAURACION DE ANTICUA FERRETERIA MACAYA

DISEÑO: ARQUITECTO ELIAS ROBLES FERNANDEZ

AGOSTO 2011



Tekna Constructores CRS S.A.
 Of. 2281-3637 Fax 2281-3738
 PO. Box 252-2050

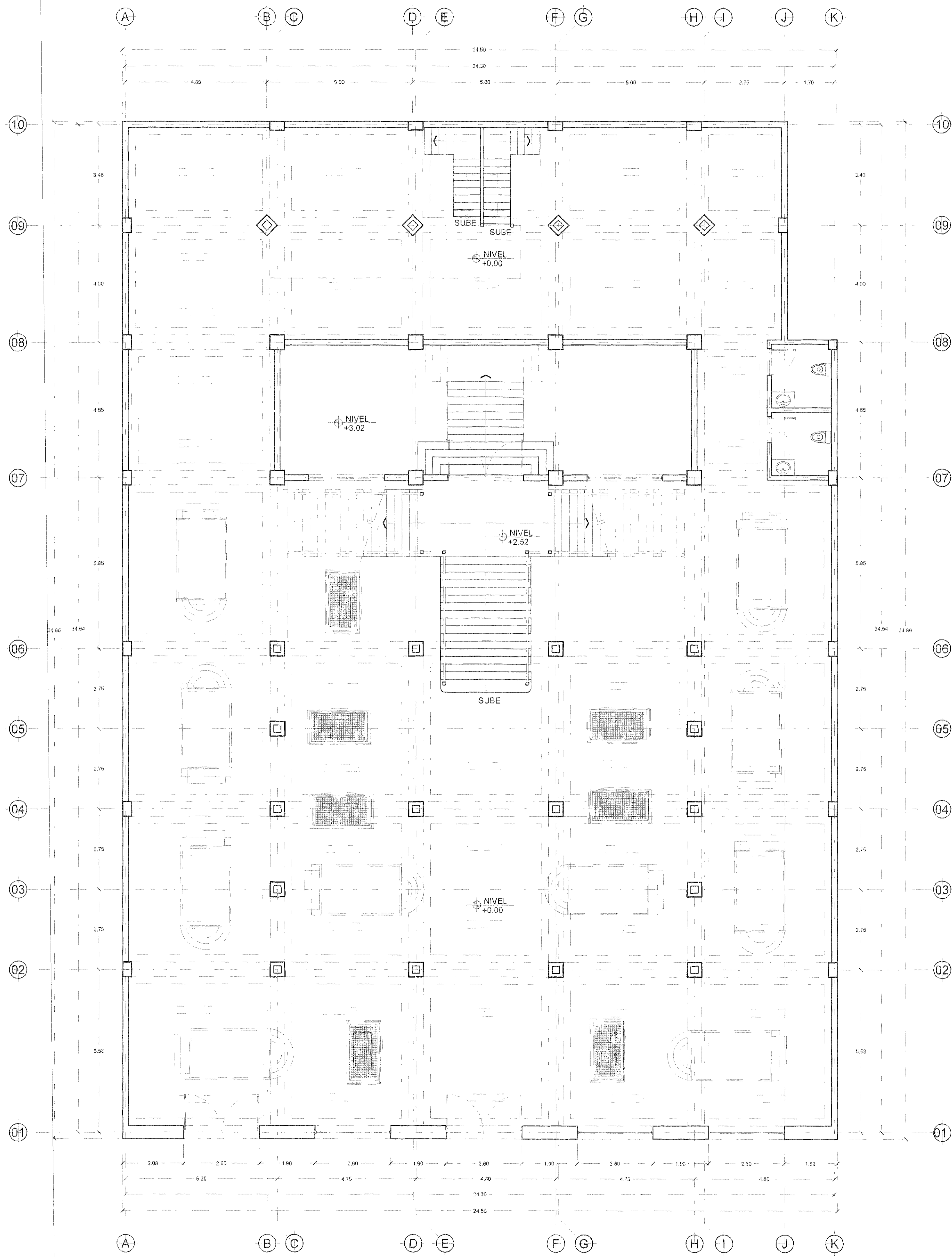
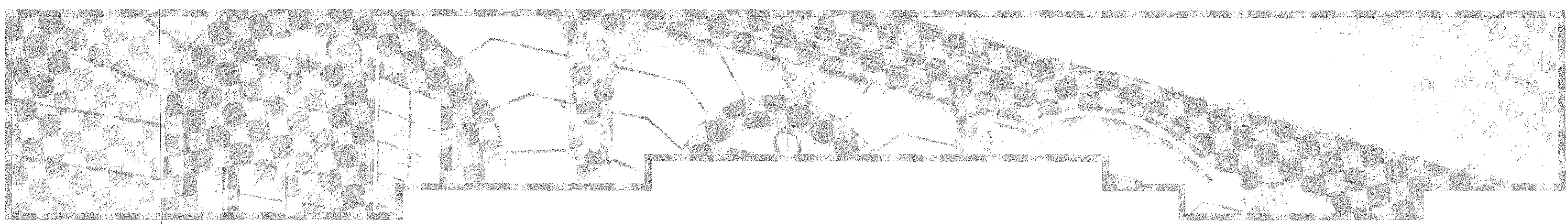

PLANTA DE DISTRIBUCION ARQUITECTORICA
NIVEL +0.00ms PROPUESTA ARQUITECTORICA ESCALA 1:75

PROYECTO:

RESTAURACION DE ANTICUA FERRETERIA MACAYA

DISENO: ARQUITECTO ELIAS ROELIS FERNANDEZ

AGOSTO 2011



Tekna Constructores CRS S.A.
Of. 2281-3637 Fax 2281-3738
PO. Box 252-2050

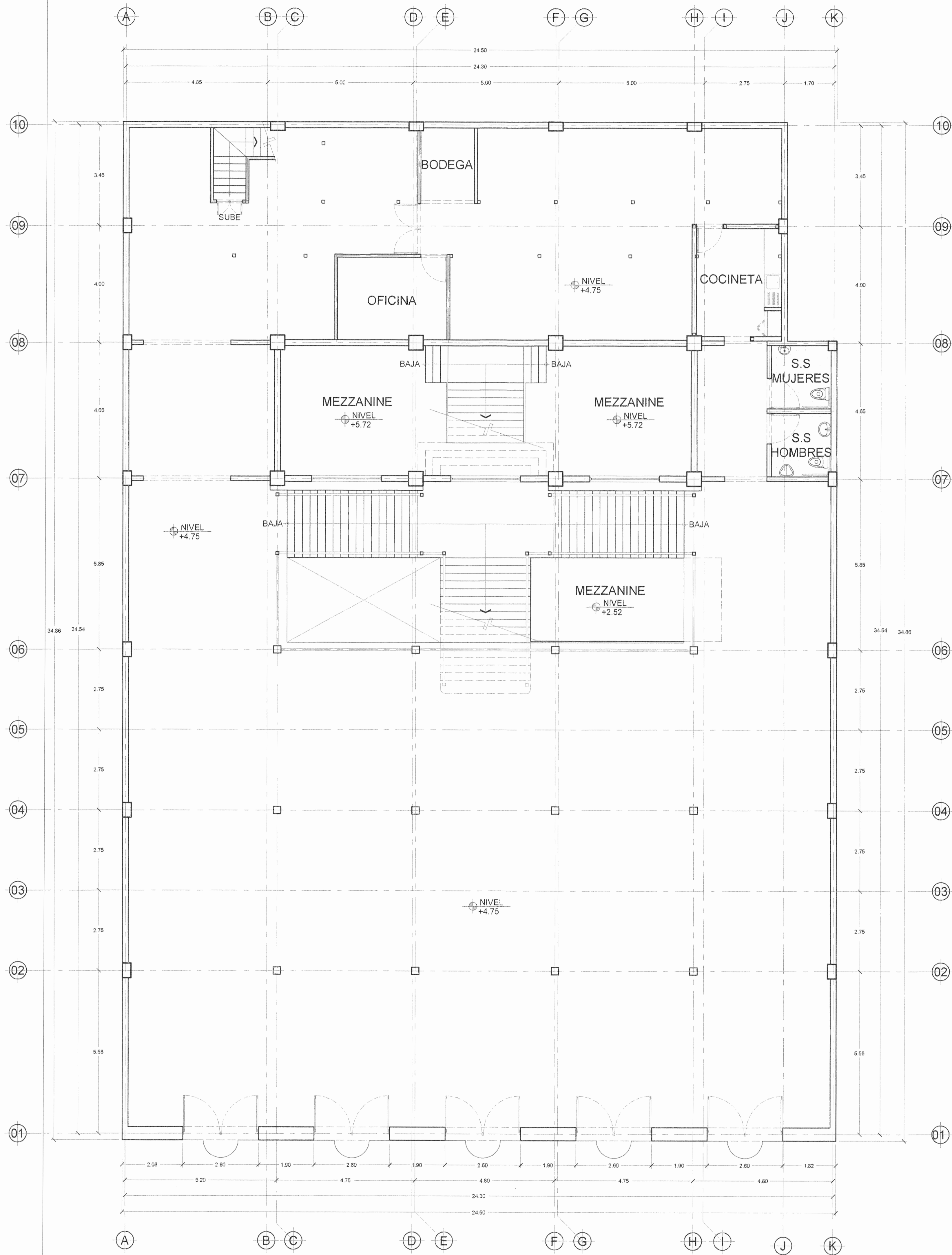
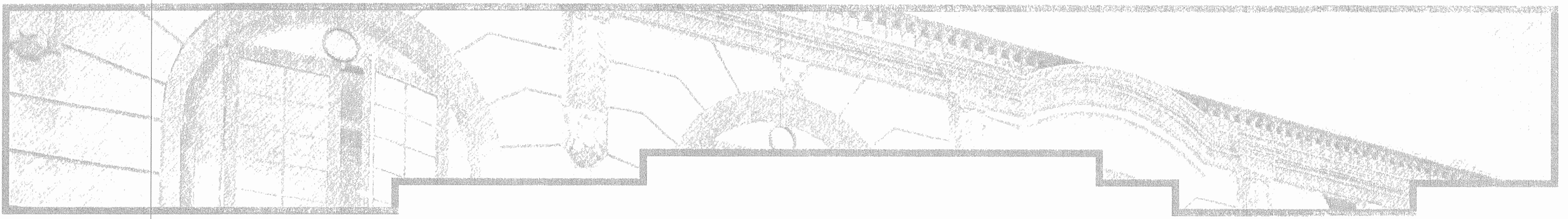

PLANTA DE DISTRIBUCION ARQUITECTONICA
 NIVEL 2 +4.75mts EDIFICIO EXISTENTE
 ESCALA 1:75

PROYECTO:

RESTAURACION DE ANTICUA FERRETERIA MACAYA

DISEÑO: ARQUITECTO ELIAS ROELIS FERNANDEZ

AGOSTO 2011



Tekna Constructores CRS S.A.
 Of. 2281-3637 Fax. 2281-3738
 P.O. Box 252-2050

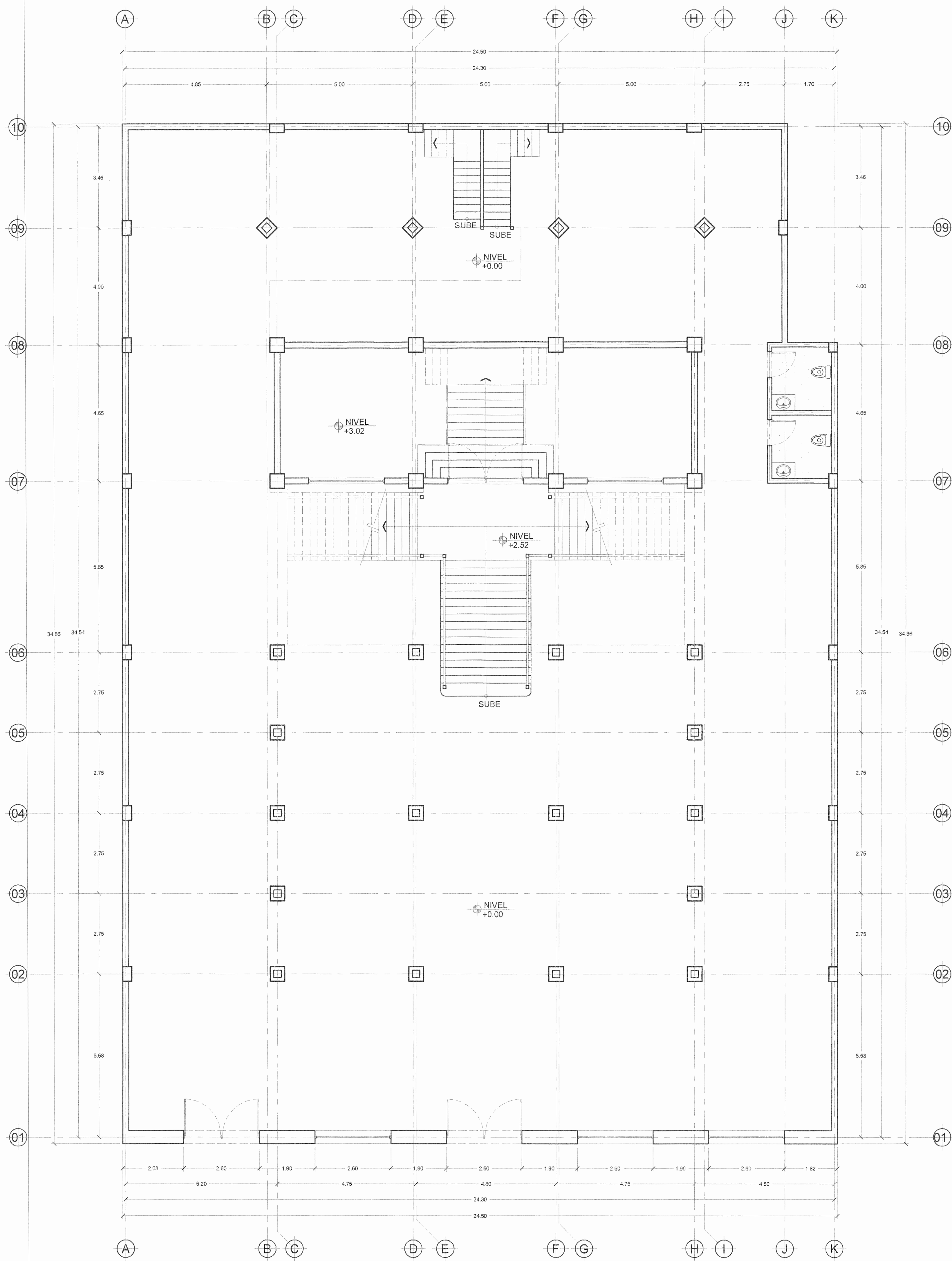
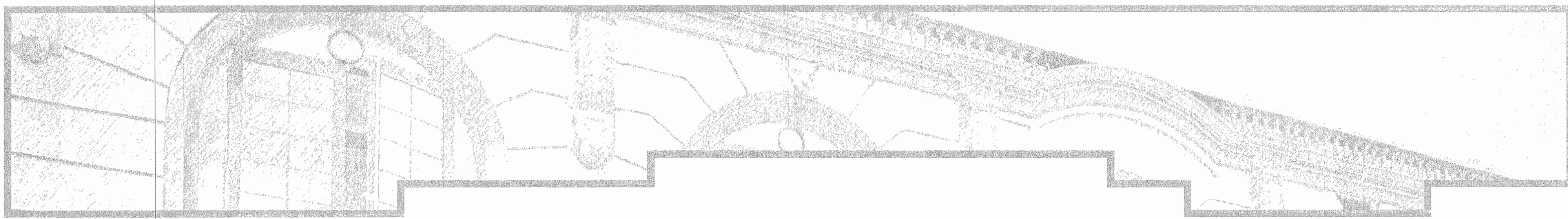

PLANTA DE DISTRIBUCION ARQUITECTONICA
 NIVEL 1 +0.00mts EDIFICIO EXISTENTE
 ESCALA 1:75

PROYECTO:

RESTAURACION DE ANTICUA FERRETERIA MACAYA

DISEÑO: ARQUITECTO ELIAS ROBLES FERNANDEZ

AGOSTO 2011



Tekna Constructores CRS S.A.
 Of. 2281-3637 Fax. 2281-3738
 PO. Box 252-2050